



I-V600

User manual



TABLE OF CONTENTS

1. SAFETY MEASURES AND PRECAUTIONS3

 1.1. Preliminary instructions 3

 1.2. During use 4

 1.3. After use 4

 1.4. Definition of measurement category (overvoltage)..... 4

2. GENERAL DESCRIPTION5

 2.1. Foreword 5

 2.2. Instrument functions 5

3. PREPARATION FOR USE6

 3.1. Initial checks 6

 3.2. Instrument power supply 6

 3.3. Storage..... 6

4. DESCRIPTION OF PARTS7

 4.1. Instrument description 7

 4.2. Description of function keys 8

 4.3. Display description 9

 4.4. Initial screen 9

 4.5. Side menu 10

 4.6. Description of the states of the SOLAR03 remote unit..... 10

 4.7. Using instrument while it is hanging and attached to a strap 11

5. MAIN MENU13

 5.1. Help 13

 5.2. Instrument Settings 14

 5.3. Information 15

6. OPERATING INSTRUCTIONS.....16

 6.1. DMM – Multimeter function 16

 6.2. SOLAR03 - Remote unit..... 17

 6.3. DB – PV modules database management 22

 6.3.1. How to define a new PV module..... 24

 6.3.2. Modification of a PV module 25

 6.3.3. Searching for PV modules in the database 26

 6.3.4. Deleting a PV module 27

 6.3.5. Restore PV modules database 28

 6.4. I-V – Measuring the I-V curve..... 29

 6.4.1. General information 29

 6.4.2. I-V Curve test without remote unit SOLAR03 30

 6.4.3. I-V Curve test with remote unit SOLAR03 in direct connection 34

 6.4.4. I-V Curve test with remote unit SOLAR03 in synchronous recording..... 40

 6.4.5. Interpretation of measurement results 47

 6.4.6. Anomalous situations..... 49

 6.5. IVCK – Commissioning Test on PV modules and strings 53

 6.5.1. General information 53

 6.5.2. IVCK test without remote unit SOLAR03..... 54

 6.5.3. IVCK test with remote unit SOLAR03 in direct connection..... 59

 6.5.4. IVCK test with remote unit SOLAR03 in synchronous recording..... 63

 6.5.5. Interpretation of measurement results 70

7. MEM - STORAGE OF RESULTS73

 7.1. Saving measures..... 73

 7.2. Displaying results 77

 7.3. Deleting results..... 80

 7.3.1. Anomalous situations..... 82

8. CONNECTING THE INSTRUMENT TO THE PC84

9. MAINTENANCE85

 9.1. General information..... 85

 9.2. Replacing or recharging internal batteries..... 85

 9.3. Instrument cleaning 85

10. TECHNICAL SPECIFICATIONS	86
10.1. Technical characteristics	86
10.2. General characteristics.....	87
10.3. Environmental conditions for use	88
10.4. Accessories	88
11. APPENDIX	89
11.1. Theoretical aspects of the I-V curve measurement.....	89
11.1.1. Theoretical Aspects of I-V Curve measurement.....	89
11.2. Typical errors on I-V curves and troubleshooting.....	90
12. SERVICE.....	92
12.1. Warranty conditions.....	92
12.2. Service	92

1. SAFETY MEASURES AND PRECAUTIONS

This instrument has been designed to comply with the IEC/EN61010-1 Directive on electronic measurement equipment. Before and during measurement, carefully follow the instructions below and read all the notes preceded by the symbol .

- Do not take voltage or current measurements in humid environments
- Do not take measurements near explosive gases or materials and fuels, or in dusty environments
- Avoid contact with the circuit being tested if no measurement is being taken
- Avoid contact with exposed metal parts, unused measurement terminals, circuits, etc.
- Do not take any measurements if you notice any abnormalities in the instrument, such as deformation, breakage, leakage of substances, no reading on the display, etc.
- Only use original HT accessories
- **When closing the case, DO NOT LEAVE ANY ACCESSORIES inside in order to not damage the instrument's display**

The following symbols are used in this manual and on the instrument:



CAUTION: follow the instructions given in this manual; improper use may cause damage to the instrument, its components or dangerous situations for the operator.



High voltage: risk of electric shock



Double insulation



DC voltage or current



This symbol indicates that the equipment, the batteries and its accessories must be collected separately and disposed of in the correct manner

1.1. PRELIMINARY INSTRUCTIONS



- **The instrument has been designed to be used in the environmental conditions specified in § 10.3. The presence of significantly different environmental conditions can compromise the safety of the instrument and the operator. In any case, before using, wait until the conditions inside the instrument are comparable to the conditions of the environment in which it is operating**
- The instrument can be used for **VOLTAGE** and **CURRENT** measurements in CAT III 1500VDC with a maximum voltage of 1500VDC between inputs and a maximum current of 40A. Do not work on circuits that exceed the limits specified in § 10.1
- We recommend that you follow normal safety procedures to protect yourself from dangerous currents and to protect the equipment from misuse
- Only the accessories supplied with the instrument guarantee compliance with the safety standards. They must be in good condition and must be replaced, if necessary, with identical models
- Check that the batteries are inserted correctly
- Before connecting the measurement cords to the circuit being tested, check that the desired function has been selected

1.2. DURING USE

Read the following recommendations and instructions carefully:



CAUTION

- Failure to comply with the warnings and/or instructions may result in damage to the equipment and/or its components or personal injury to the operator
- Do not touch any unused test terminal
- Do not disconnect the cords during measurement
- Do not open the battery compartment when the instrument inputs are connected
- The symbol  indicates that the internal batteries are fully charged. When the charge level drops to the minimum level, the symbol  appears on the display. In this case, stop the tests and replace or recharge the batteries as described in § 9.2
- **The instrument will not charge the batteries if the temperature is outside the permitted range of them (0°C ÷ 40 °C / 32°F ÷ 104°F)**
- **The instrument retains data even without batteries**

1.3. AFTER USE

When measurements are complete, switch off the instrument by pressing and holding the **ON/OFF** key for some seconds. If the instrument is not to be used for a long period, remove the batteries and follow the instructions in § 3.3.

1.4. DEFINITION OF MEASUREMENT CATEGORY (OVERVOLTAGE)

Standard IEC/EN61010-1: Safety requirements for electrical equipment for measurement, control and laboratory use, Part 1: General requirements”, defines what measurement category, commonly called overvoltage category, is. In § 6.7.4: Measuring circuits, it states that:

Circuits are divided into the following measurement categories:

- **Measurement Category IV** is for measurements performed at the source of the low-voltage installation.
Examples are electricity meters and measurements on primary overcurrent protection devices and ripple control units.
- **Measurement Category III** is for measurements performed in the building installation
Examples are measurements on distribution boards, circuit breakers, wiring, including cables, bus-bars, junction boxes, switches, socket-outlets in the fixed installation, and equipment for industrial use and some other equipment, for example, stationary motors with permanent connection to fixed installation.
- **Measurement Category II** is for measurements performed on circuits directly connected to the low voltage installation.
Examples are measurements on household appliances, portable tools and similar equipment.
- **Measurement Category I** is for measurements performed on circuits not directly connected to MAINS.
Examples are measurements on circuits not derived from MAINS, and specially protected (internal) MAINS-derived circuits. In the latter case, transient stresses are variable; for that reason (OMITTED) the user must know the transient withstand capability of the equipment

2. GENERAL DESCRIPTION

2.1. FOREWORD

The instrument is designed to carry out performance measurements (I-V curve) and quick pre-testing (IVCK) of photovoltaic (PV) modules/strings in accordance with IEC/EN60891 and IEC/EN62446-1.

2.2. INSTRUMENT FUNCTIONS

The instrument can perform tests on Monofacial and Bifacial modules/strings up to 1500VDC, 40ADC.

Measurement of I-V Curve (I-V)

The following functions are available on the instrument:

- Activation of Manual or Automatic measurement (*)
- Measurement of Voltage/Current/Power under operating conditions (@OPC)
- Measurement of Voltage/Current/Power referring to standard conditions (@STC) in accordance with IEC/EN60891
- I-V curve diagram and Power/Voltage under @OPC and @STC condition
- Direct comparison of the @STC values with the nominal values declared by the manufacturer and display of OK/NO result

Commissioning test measurements (IVCK)

- Open circuit voltage measurement VOC
- Short-circuit current measurement ISC
- Display of results under @OPC and @STC conditions in accordance with IEC/EN62446-1 and IEC/60891
- OK/NO evaluation of results

General characteristics

- The instrument is supplied in a carrying case with IP67 mechanical protection.
- Safety sliding cover on inputs
- Large graphic colour display (800x480pxl) with capacitive touch-screen
- Internal icon-based menus for intuitive user interface
- Auto power-off (can be disabled) after approx. 5 minutes of inactivity
- HELP function for information on instrument connections
- The instrument is powered by alkaline batteries or NiMH batteries rechargeable via the external power supply unit (provided)
- Measurement of front-side and back-side irradiance and temperature of PV modules via Bluetooth connection with the **SOLAR03** remote unit, **HT305** reference cell and **PT305** temperature probe
- Customisable internal database for managing up to ca 63.000 PV modules
- 32GB memory card (not expandable) for data storage
- USB-C and WiFi interface for data transfer to PC and dedicated APP (*)

() The feature may only be available on certain models*



3. PREPARATION FOR USE

3.1. INITIAL CHECKS

The electronics and mechanics of the instrument have been carefully checked before shipment. Every precaution has been taken to ensure that the instrument is delivered in perfect condition. In any case, it is advisable to check it for any damage that may have occurred during transport. If any faults are found, please contact your dealer immediately. It is also advisable to check that the packaging contains all the parts listed in § 10.4 . In case of discrepancies, please contact your dealer. Should it be necessary to return the instrument, please follow the instructions given in § 12

3.2. INSTRUMENT POWER SUPPLY

The instrument is powered by 8x1.5V AA-type alkaline batteries or 8x1.2V AA-type NiMH batteries rechargeable via external power supply unit supplied as standard.

For information on battery operations see § 9.2. The symbol “” indicates that the internal batteries are fully charged. When the charge level drops to the minimum level, the symbol “” appears on the display. In this case, stop the tests and replace the alkaline batteries or recharge the NiMH batteries as described in § 9.2.



CAUTION

- The instrument retains data even without batteries
- The instrument will not charge the batteries if the temperature is outside the permitted range of them (0°C ÷ 40 °C / 32°F ÷ 104°F)

3.3. STORAGE

The instrument has been designed to be used in the environmental conditions specified in § 10.3. The presence of significantly different environmental conditions can compromise the safety of the instrument and the operator and/or not guarantee precise measurements.

After a long period of storage and/or in extreme environmental conditions, wait until the conditions inside the instrument are comparable to those in the environment in which it will be used.



CAUTION

The instrument automatically switches on cooling fans in case of overheating

4. DESCRIPTION OF PARTS
4.1. INSTRUMENT DESCRIPTION

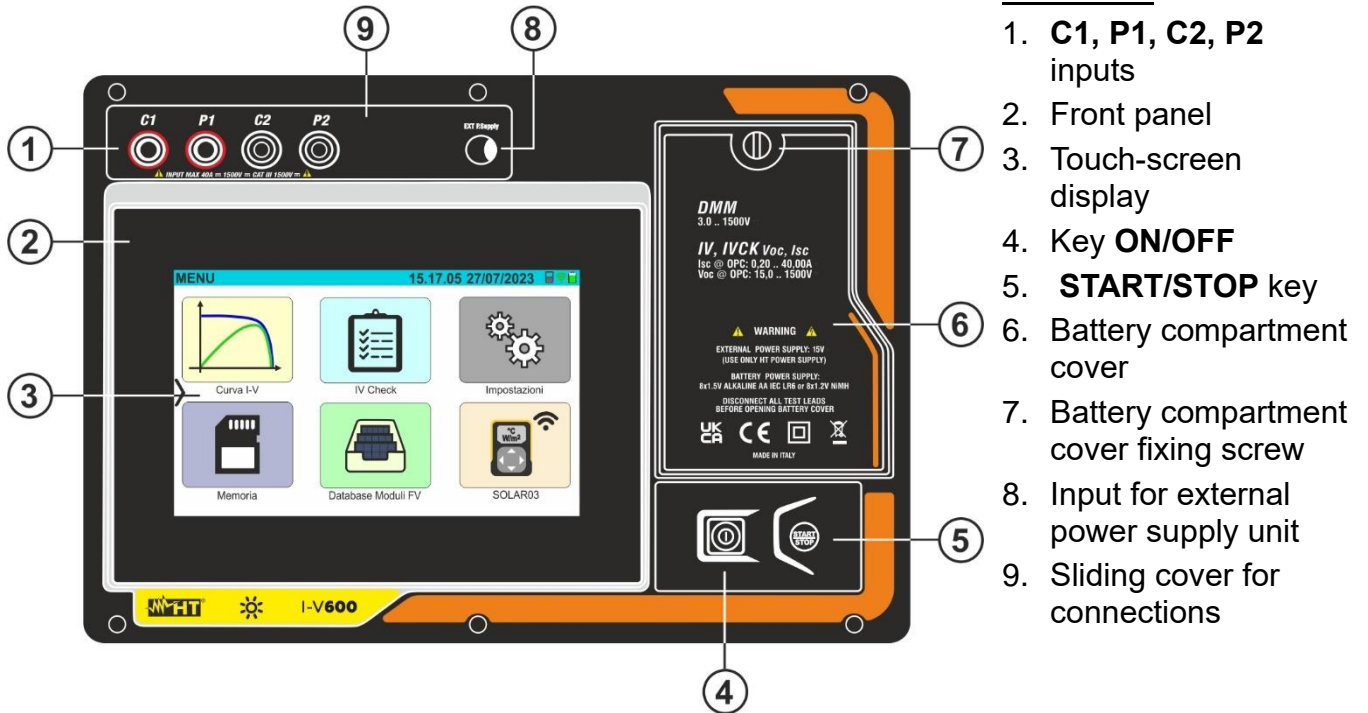

- CAPTION:**
1. **C1, P1, C2, P2** inputs
 2. Front panel
 3. Touch-screen display
 4. Key **ON/OFF**
 5. **START/STOP** key
 6. Battery compartment cover
 7. Battery compartment cover fixing screw
 8. Input for external power supply unit
 9. Sliding cover for connections

Fig. 1: Description of the front part of the instrument

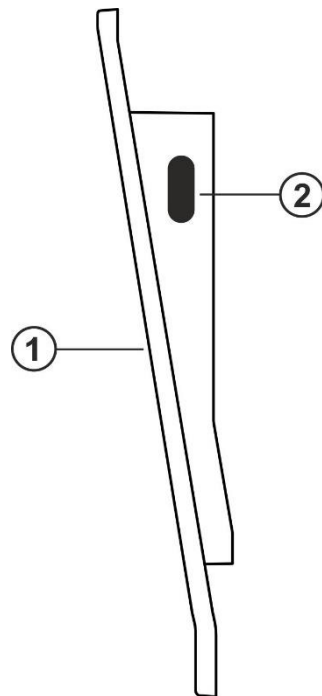

- CAPTION:**
1. Front panel
 2. USB-C connector for PC connection

Fig. 2: Description of the instrument's side

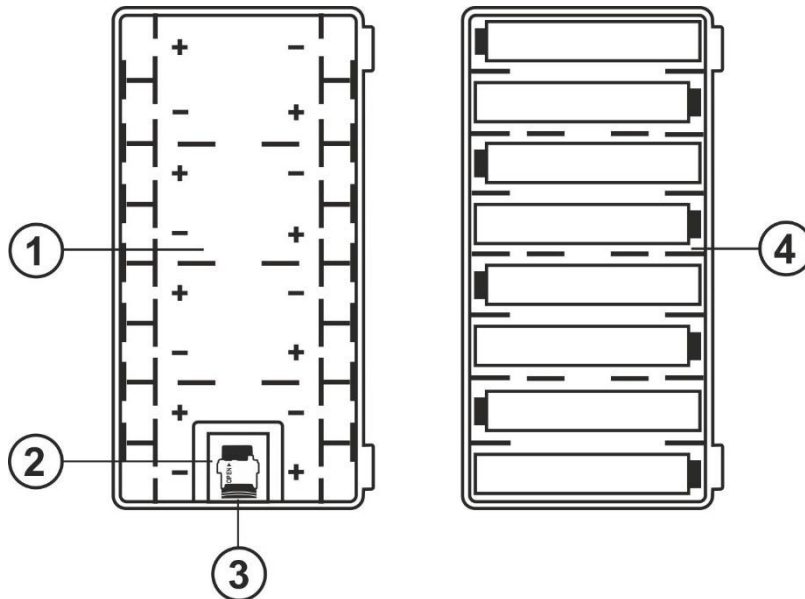

CAPTION:

1. Battery compartment with battery polarity indicator
2. Slot for memory card
3. Memory card
4. Position of batteries inside the compartment

Fig. 3: Description of instrument battery compartment



CAUTION

The memory card (see Fig. 3 – part 3), in addition to managing saving data, contains basic information on the internal functions of the instrument and **must NOT be removed, modified or replaced** unless explicitly requested by the HT service assistance

4.2. DESCRIPTION OF FUNCTION KEYS

The instrument includes the following function keys:



- **ON/OFF** key → Press the key for **at least 2s** to switch the instrument on or off. A green light briefly surrounds the key when it is switched on
- **ON/OFF** key → in **presence** of the external power supply connected, **after 30s of inactivity** (no action on the keyboard and touch screen, no sending of commands via USB/WiFi, no disconnection of the power supply), the instrument turns off the display and a flashing **green** light surrounds the button. **Double-tap** the touch screen or perform any other action to turn the display back on



- **ON/OFF** key → in **absence** of an external power supply connected, **after 30s of inactivity** (no action on the keyboard and touch screen, no sending of commands via USB/WiFi, no disconnection of the input terminals) the instrument turns off the display and a **red-light** flashing surrounds the button. **Double-tap** the touch screen or perform any other action to turn the display back on



- **START/STOP** key → Press the key to start a measurement. A green light briefly surrounds the key when it is switched on

4.3. DISPLAY DESCRIPTION

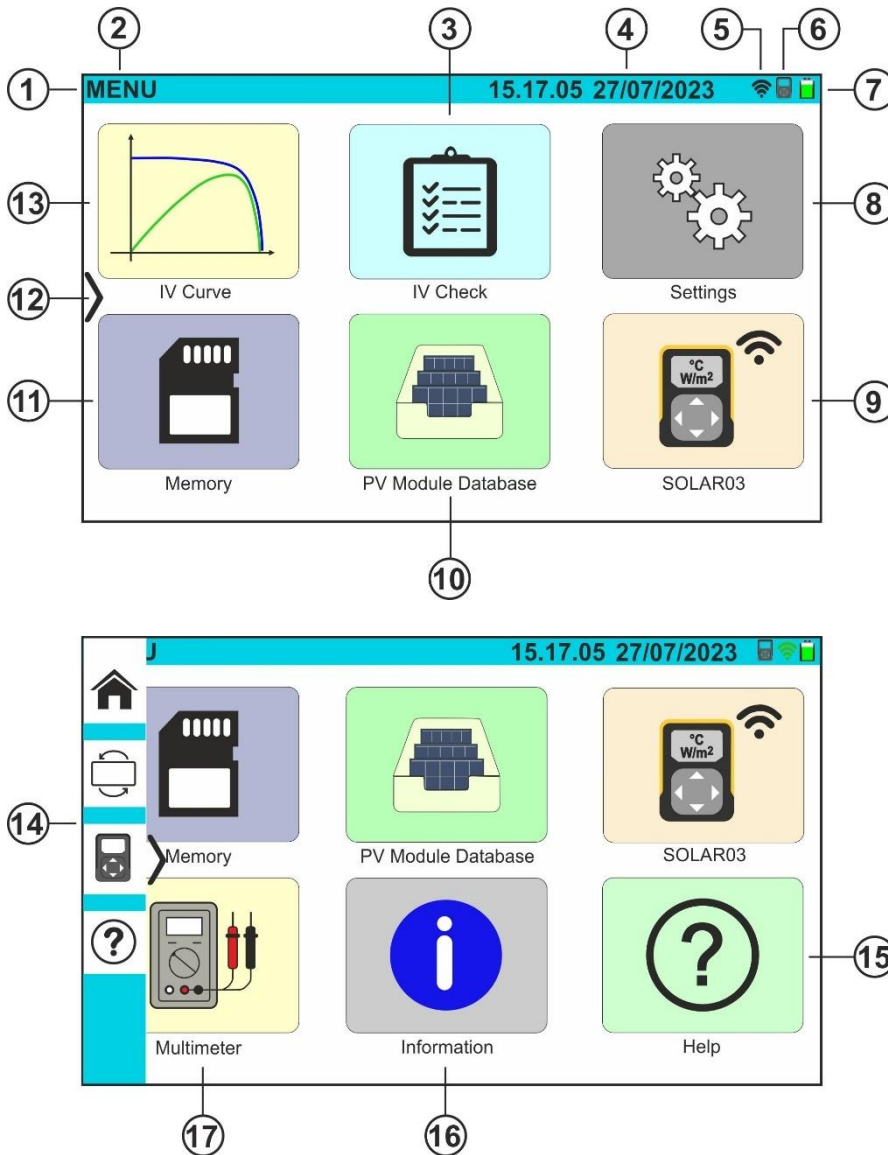

CAPTION:

1. System bar
2. Active menu indication
3. **IV Check** function icon
4. System date/time indicator
5. WiFi connection active indicator
6. SOLAR03 connected indicator
7. Battery level indicator
8. **Settings** icon
9. **SOLAR03** icon
10. **PV Modules DataBase** icon
11. **Memory** icon
12. Side menu bar enable/disable icon
13. **IV Curve** icon
14. Side menu bar
15. **Help** icon
16. **Information** icon
17. **Multimeter** icon

Fig. 4: Display description

4.4. INITIAL SCREEN





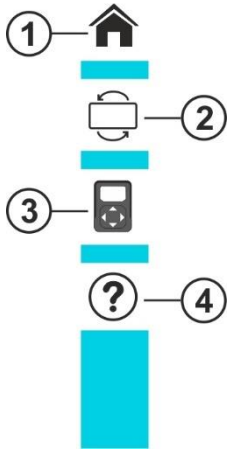

When switched on, the instrument briefly displays the initial screen before switching to the main menu. It shows:

- The manufacturer's logo
- The instrument's model
- The serial number of the instrument (S/N:)
- The internal firmware (FW) and hardware (HW) versions
- The date of the last calibration carried out on the instrument (Calibration Date:)

4.5. SIDE MENU



Tap on the icon ">" to open/close the side bar/menu shown in the figure on the left. The following icons are available:

1.  **HOME** icon→, used to go back to the main menu from any screen displayed on the instrument
2.  **REVERSE** icon→, used to rotate the display for reading the values when the instrument is hanging (see § 4.7)
3.  **SOLAR03** icon→, used to access the management section of the **SOLAR03** remote unit from any screen displayed on the instrument
4.  **HELP** icon→, used to access the 'Help' section from any screen displayed on the instrument

4.6. DESCRIPTION OF THE STATES OF THE SOLAR03 REMOTE UNIT

Depending on how it is used in conjunction with the instrument, the **SOLAR03** remote unit can be in one of the following states, identified by the symbol at the top of the display (see Fig. 4- section 5):



SOLAR03 remote unit connected to the instrument



SOLAR03 remote unit connected to the instrument and recording



SOLAR03 remote unit **NOT connected** to the instrument



SOLAR03 remote unit recording, but out of connection range

4.7. USING INSTRUMENT WHILE IT IS HANGING AND ATTACHED TO A STRAP

For measurements where it is useful to hang the instrument, it is advisable to remove the cover from the case. To do so, proceed as follows:

1. Open the case and turn the two locking pins as shown in Fig. 5

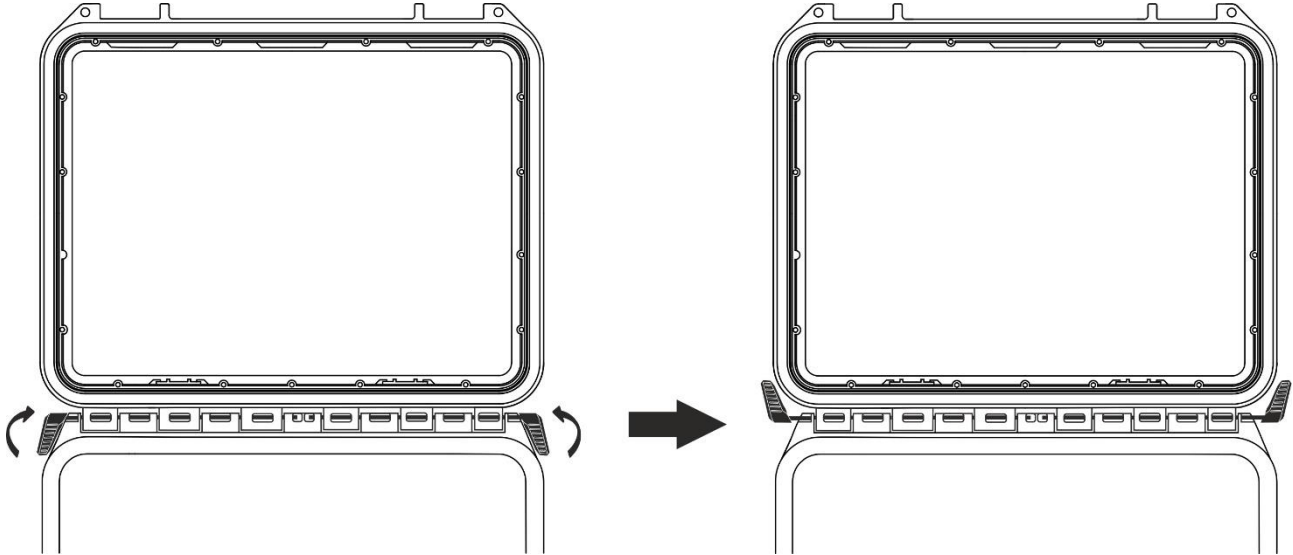

Fig. 5: Removing the cover from the instrument case - Step 1

2. Remove the two locking pins by pulling them outwards as shown in Fig. 6

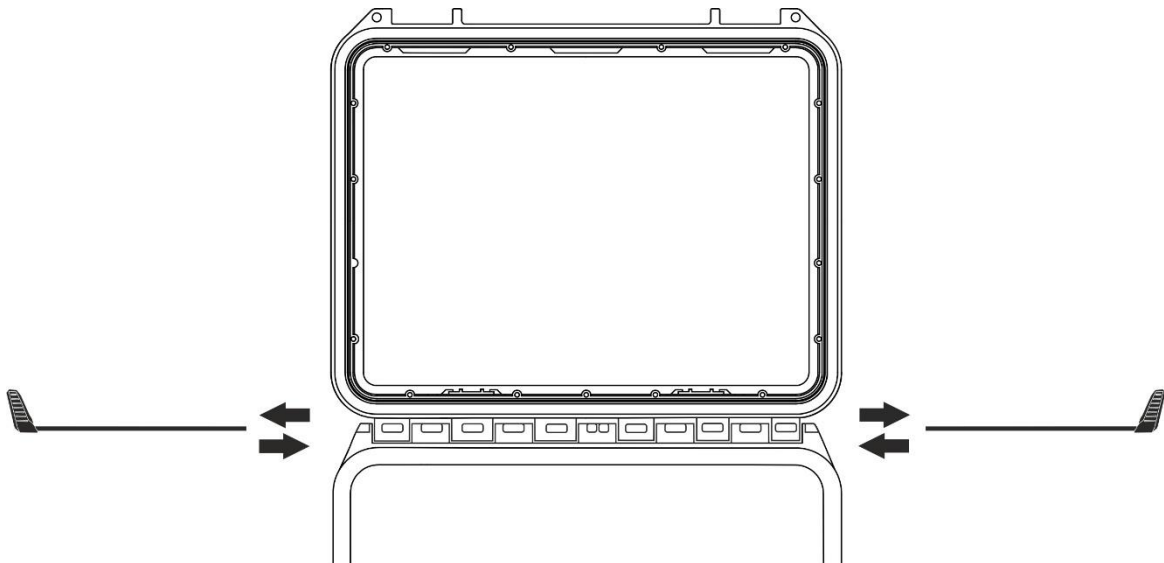

Fig. 6: Removing the cover from the instrument case - Step 2

3. Remove the case cover from its housing as shown in Fig. 7

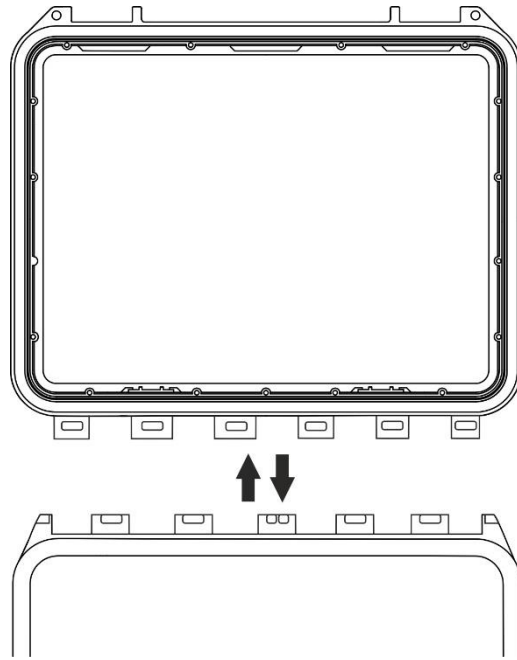

Fig. 7: Removing the cover from the instrument case - Step 3

4. Connect the **SP-2003** strap (supplied) to the instrument as shown in Fig. 8. In this case, it is useful to rotate the display by 180° by tapping on the **REVERSE** key in the side menu (see § 4.5) or by activating the "**Rotate display**" option (see § 5.2)



Fig. 8: Using the instrument with strap attached and display rotated

5. Repeat steps 3), 2), 1) in reverse order to put back the case cover

5. MAIN MENU

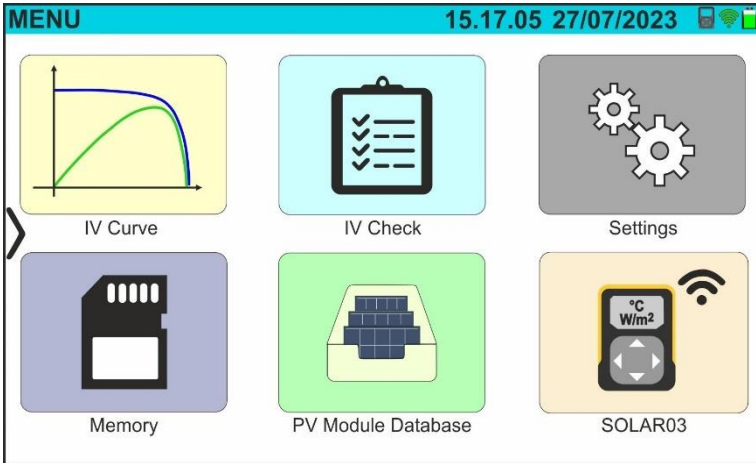

The instrument's main menu contains a series of icons used to access the internal measurements and settings.

The instrument is controlled and programmed using the touch-screen display only, with no external function keys.

The main menu consists of two pages. The first page is always displayed when the instrument is switched on.

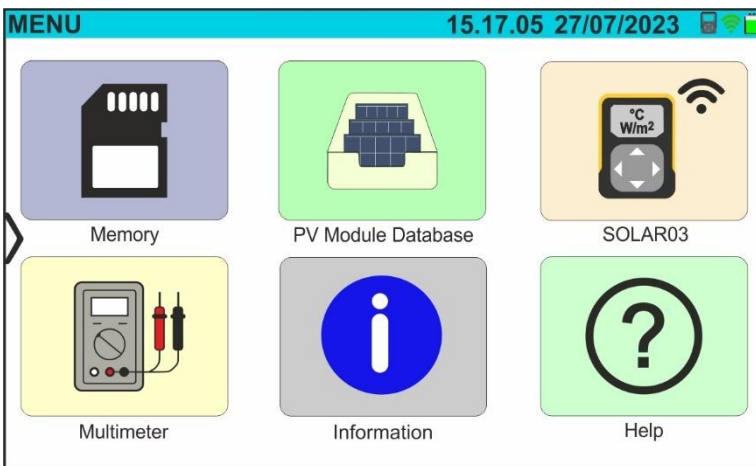

Slide your finger up and down the screen to access the second page, as shown in the screen on the side

5.1. HELP

1. Tap on the "Help" icon on the main menu. The following screen will be displayed:

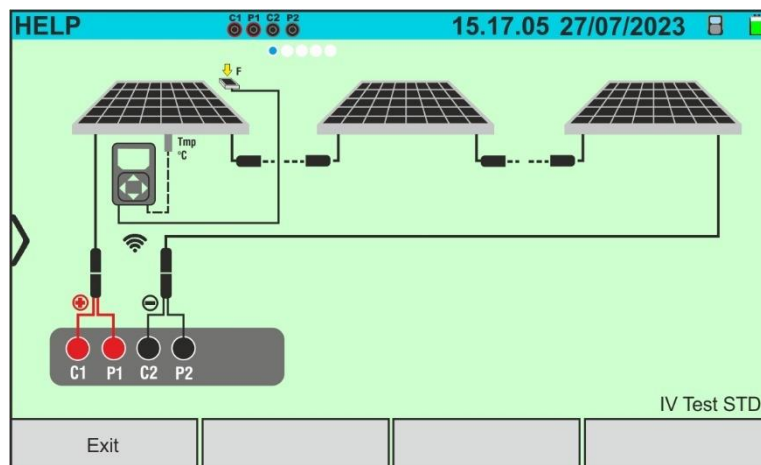

Fig. 9: Help screen for connecting to the instrument

2. Scroll left to view the help screens for the various measurements performed by the instrument
3. Tap on the "Exit" key to exit and return to the main menu

5.2. INSTRUMENT SETTINGS

1. Switch on the instrument using the **ON/OFF** key
2. Tap on the "**Settings**" icon on the main menu. The following screen will be displayed



Fig. 10: General instrument settings

3. Drag each of the 7 thumb wheels to the right or left to set the desired value for each parameter in the "General" section. The following items are available:
 - **Language** → system language setting
 - **Min. irradiance** → to set the minimum irradiance threshold considered by the instrument when measuring the I-V curve and the IVCK in the range: **100 W/m² ÷ 1100W/m²** in 100 W/m² increments
 - **Auto Power Off** → to set the instrument auto-off time between the following values: **0min (No Auto Power Off), 1min to 10min** in 1min increments
 - **Contrast** → to set the percentage of display contrast in the range: **0% to 99%** in 5% increments
 - **Key sound** → to enable (**ON**) or disable (**OFF**) the key beep each time the touch-screen display is touched
 - **WiFi** → to enable (**ON**) or disable (**OFF**) the WiFi connection that can only be used to connect the instrument to a PC (via a management software HTAgorà) or mobile devices via dedicated APP (*)
 - **Rotate display** → to enable (**ON**) or disable (**OFF**) the rotation of the display (this function can also be executed from the side menu - see § 4.5)
 - **Reset Database** → see the § 6.3.5

(*) *The feature shown may only be available on certain models*

4. Tap on the icon to save the settings and return to the main menu, or on the icon to exit without saving
5. Tap on "**Date&Time**" to set the date/time of the system. The following screen will be displayed:

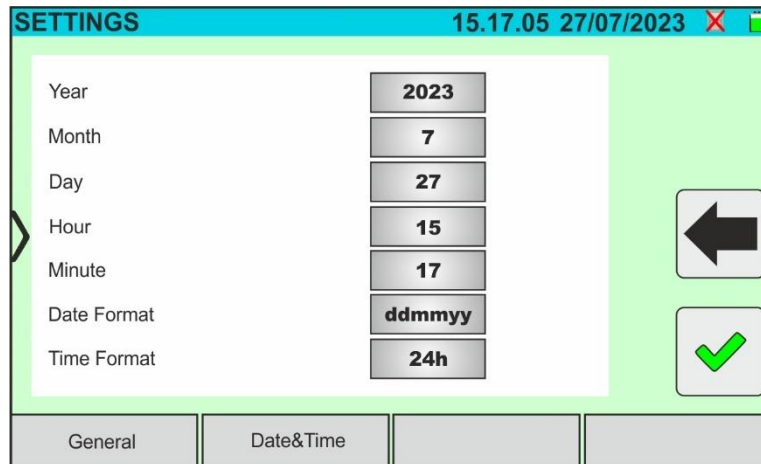



Fig. 11: Setting the date/time of the system

6. Drag each of the 7 thumb wheels to the right or left to set the desired value of each parameter in the "Date/Time" section. The following items are available:

- **Year** → to set the current year
- **Month** → to set the current month
- **Day** → to set the current day
- **Time** → to set the current time
- **Minute** → to set the current minute
- **Date Format** → to choose the date format from the following options: "**ddmmyy**" (day/month/year) or "**mmddy**" (month/day/year)
- **Time Format** → to choose the time format from the following options: "**24h**" or "**12h**" (UK notation - AM/PM)

7. Tap on the  icon to save the settings and return to the main menu, or on the  icon to exit without saving

5.3. INFORMATION

1. Tap on the "**Information**" icon on the main menu. The following screen appears on the display, showing the internal information of the instrument

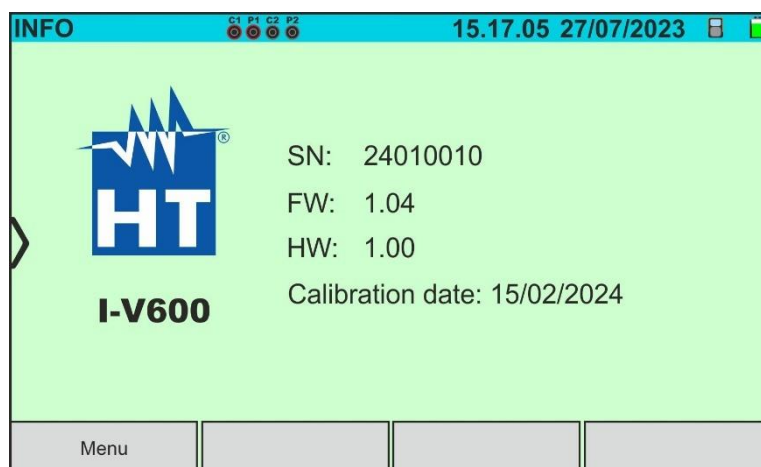

Fig. 12: Instrument information

2. Tap on the "**Menu**" key to return to the main menu

6. OPERATING INSTRUCTIONS

6.1. DMM – MULTIMETER FUNCTION

In this function, the instrument displays the DC voltage value between the positive (+) and negative (-) poles of the PV module/string/field being tested, as well as the irradiance and temperature values **when connected to a SOLAR03 remote unit**.

1. Switch on the instrument using the **ON/OFF** key
2. Connect the instrument to the PV string being tested as shown below Fig. 13

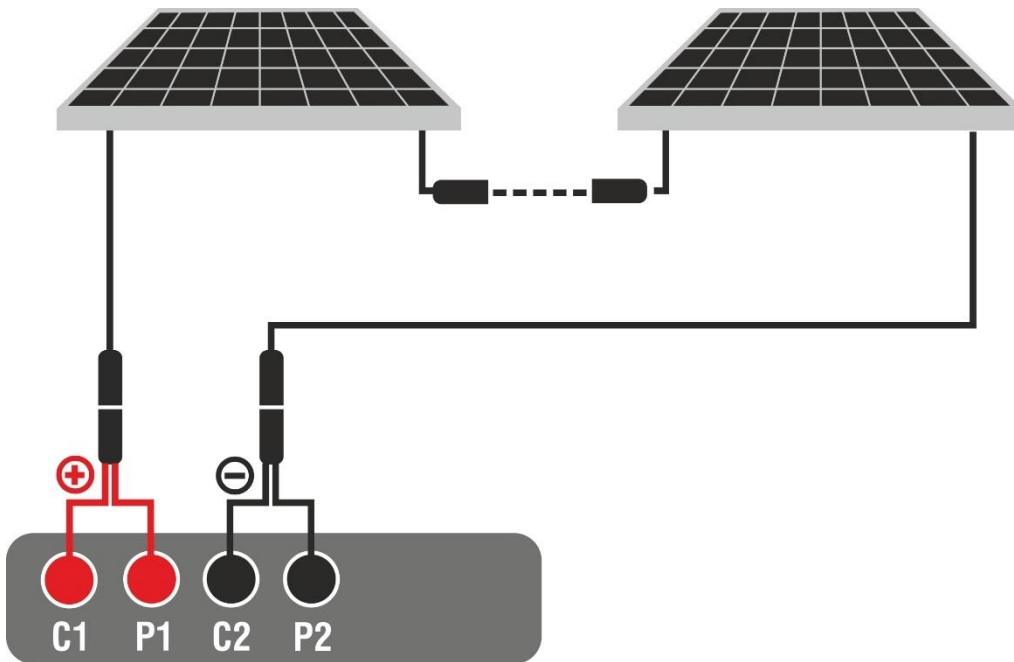

Fig. 13: Instrument connection for DMM Function

3. Tap on the "**Multimeter**" icon on the second page of the main menu. The value of the DC voltage V P-N is shown on the display as illustrated in Fig. 14. Tap on the "Menu" key to return to the main menu



Fig. 14: DMM function measurement screen (SOLAR03 disconnected)



CAUTION

The results of function DMM cannot be saved in the instrument's memory.

6.2. SOLAR03 - REMOTE UNIT

The SOLAR03 remote unit allows measuring the Irradiance and temperature values of the module, which are indispensable for the evaluation of the I-V curve, as well as the IVCK with values referenced to @STC. In general, the instrument and the SOLAR03 unit can operate in **direct connection** or **synchronous recording**.



CAUTION

- The maximum direct connection distance between the SOLAR03 unit and the instrument can be depending on the obstacles between the two units and is **up to 100m (328ft) in free air conditions**
- The maximum distance for direct connection **is indicative** as it is strongly influenced by many uncontrollable external variables. **The recommended measurement mode is always that of "synchronous recording"** (see § **Errore. L'origine riferimento non è stata trovata.**) which does not require an active Bluetooth connection during measurements and, regardless of the obstacles present and the extension of the field to be measured, **guarantees a reliable measurement in every situation**

This section manages all the operations that can be performed on the SOLAR03 remote unit in conjunction with the instrument. It is possible to:

- **Using the Bluetooth connection**, find a **SOLAR03** remote unit that can be managed by the instrument by entering it in its internal list



CAUTION

The indicative maximum communication distance via Bluetooth (up to 100m/328ft) refers to an open field, dry environment, 1m (328ft) from the ground, in the absence of obstacles and possible electromagnetic disturbances deriving from other sources close to the instruments

- Select or cancel a remote unit SOLAR03 among those present in the list;
- Pair/unpair a remote unit SOLAR03 to/from the instrument so that it can be automatically recognized upon every connection;
- Display the information of the selected remote unit.
- Activate/stop recording environmental parameters (temperature/irradiance) on a connected and active remote unit.

For each managed SOLAR03 remote unit, the instrument provides the following information:

- Serial Number
- Active (symbol ) or inactive (no symbol) remote unit
- Active remote unit connected to the instrument
- Active and connected unit in recording mode ('Rec.' symbol)

Pairing a Remote Unit

1. Switch on the instrument using the **ON/OFF** key
2. Tap on the "**SOLAR03**" icon on the main menu. The following screen will be displayed



Fig. 15: Pairing a SOLAR03 remote unit - Step 1

3. Switch on the SOLAR03 remote unit and select the "**PAIRING...**" menu (see the remote unit user manual)
4. Tap on the "**Find**" button on the instrument to start searching for the remote unit. The following screen appears on the display:

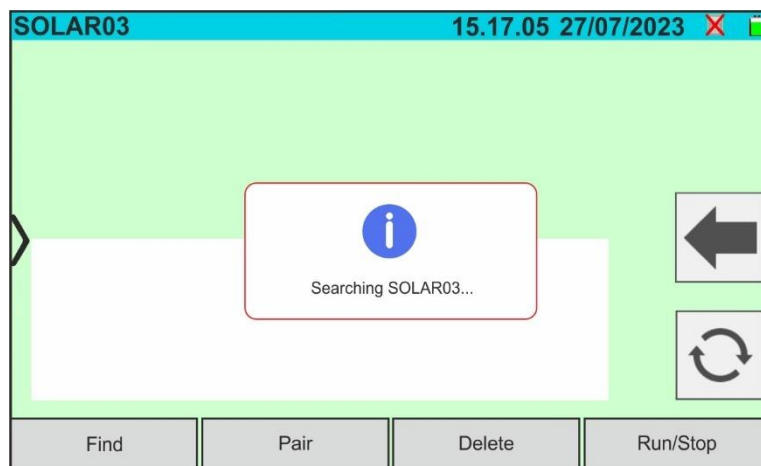

Fig. 16: Pairing a SOLAR03 remote unit - Step 2

5. Once the remote unit has been recognised, the following screen will appear on the display of the SOLAR03 unit waiting to be connected

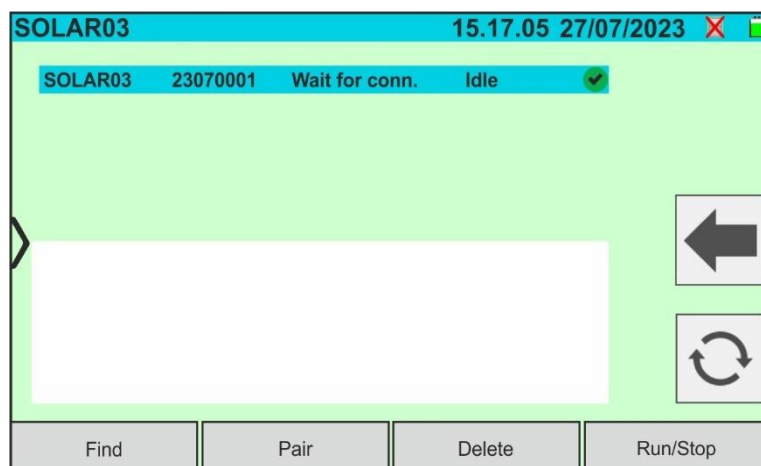

Fig. 17: Pairing a SOLAR03 remote unit - Step 3

6. **Press ENTER on the SOLAR03 remote unit** to complete the operation. After a few moments, the following screen will appear on the display:

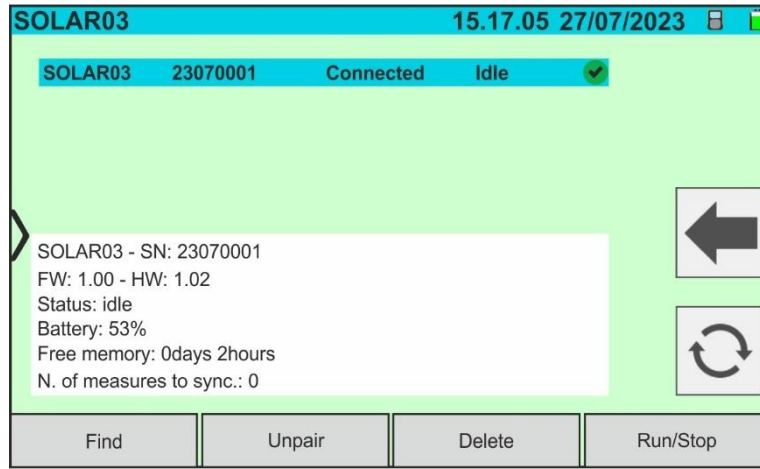



Fig. 18: Pairing a SOLAR03 remote unit - Step 4

7. From this point on, the two devices are paired and it is not necessary to repeat the above steps. To connect the instrument and the remote unit, simply switch them on, bring them close together and wait for the automatic connection. The following information is available for the paired and connected remote unit:

- Icon  in the top right corner of the display
- Model and serial number
- Internal FW and HW version of the unit
- Status: **Idle** (the instrument does not query the unit for irradiance/temperature values) or **active** (unit that provides irradiance/temperature values on measurements stored in the instrument to define values under STC conditions)
- Battery charge percentage indicator
- Indication of the space available in the internal memory for storing recordings in terms of days/hours
- Number of measurements stored in the instrument that need synchronising with the irradiance/temperature values received from the remote unit. **Tap on the  icon to synchronise measurements**

Recording activation on remote unit

8. To start recording on the connected remote unit, tap on the “**Start/Stop**” key. The following screen will appear:

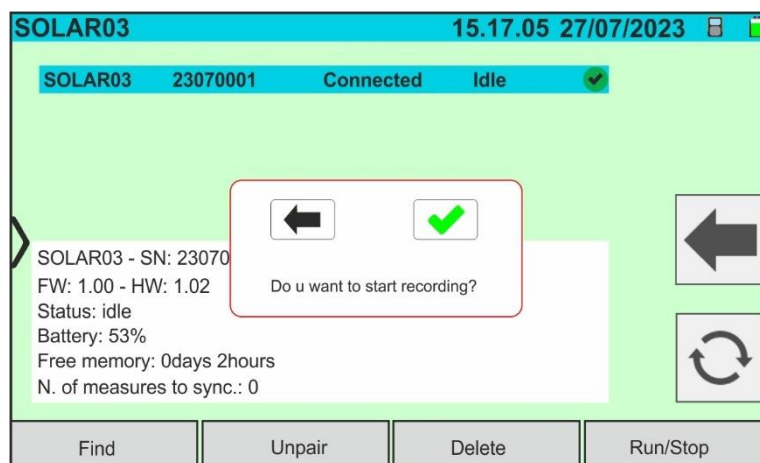



Fig. 19: Recording Activation on Remote Unit - Step 1

9. Tap on  to confirm or tap on  to exit without proceeding. If yes, the following screen will appear:

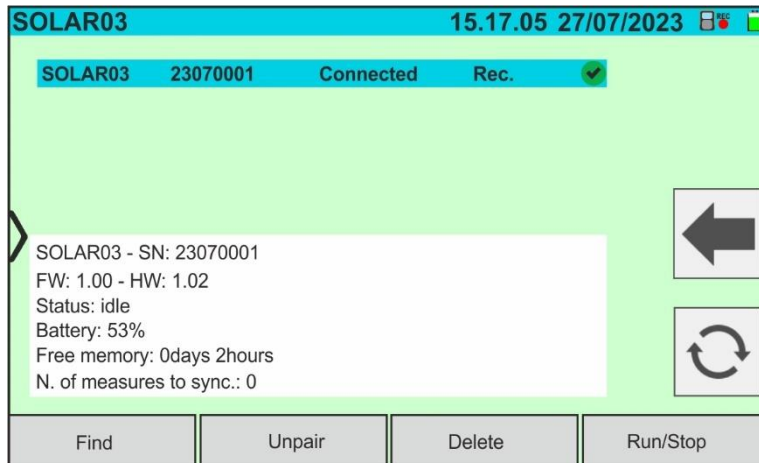



Fig. 20: Recording Activation on Remote Unit - Step 2

10. The  icon and the message "REC" appear on the display of the remote unit
 11. Tap on the "Run/Stop" button to end the recording. The following screen will appear:

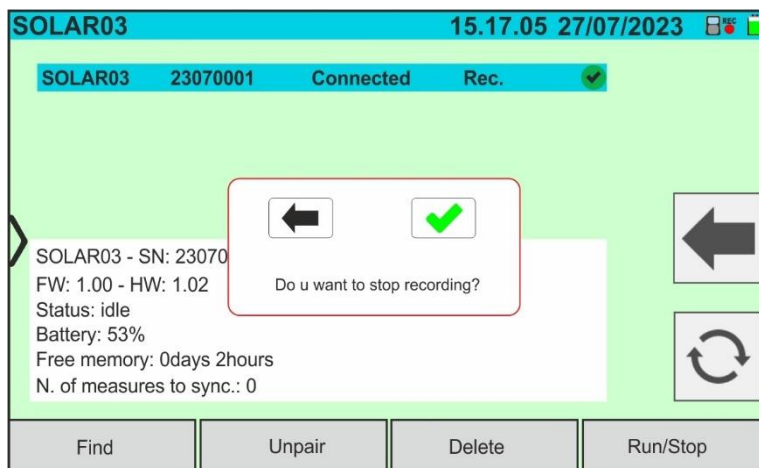



Fig. 21: End recording on the remote unit

12. Tap on the  key to confirm. The recording is **automatically** saved in the internal memory of the remote unit (see relevant user manual)
 13. Tap on the  icon to return to the main menu

Removing a remote unit

A remote unit can **only** be deleted from the unit after it has been disconnected. To this end, proceed as follows:

14. Switch off the remote unit
 15. Tap on the "Unpair" key to un-pair the remote unit. The message "Not connected" will appear on the display
 16. Tap on the "Delete" key. The following screen will appear:

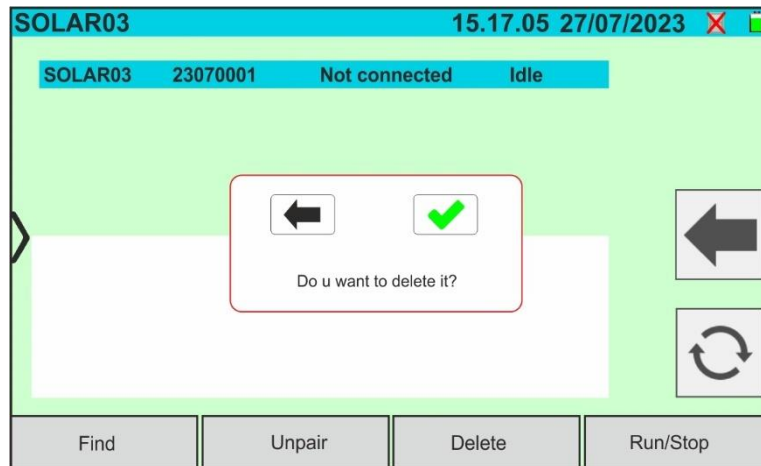



Fig. 22: Deleting a remote unit

17. Tap on the  key to confirm. The remote unit will be removed from the list; alternatively, tap on the  key to exit without proceeding

6.3. DB – PV MODULES DATABASE MANAGEMENT

The instrument allows defining and saving up to **approx. 63.000 modules**. The parameters related to 1 module and the @STC conditions that can be set are shown in Table 1 below:

Symbol	Description	Meas. Unit	Meas. range	Default
Man.	Module manufacturer	-	-	-
Name	Module name	-	-	-
Pmax	Maximum nominal power of module	W	30 ÷ 1999	400
Voc	Open circuit voltage	V	15.0 ÷ 999.99	45
Vmpp	Voltage on point of maximum power	V	15.0 ÷ 999.99	40
Isc	Short circuit current	A	1.00 ÷ 39.99	10.5
Impp	Current on point of maximum power	A	1.00 ÷ 39.99	10
Toll -	Negative tolerance for Pmax	%	0.00 ÷ 25.00	0
Toll +	Positive tolerance for Pmax	%	0.00 ÷ 25.00	1.25
TC(Isc)	Isc temperature coefficient	%/°C	-0,100 ÷ 0,100	0.03
TC(Voc)	Voc temperature coefficient	%/°C	-0,999 ÷ -0,001	-0.25
Rs	Module series resistance	Ω	0.10 ÷ 10.00	0.0
Perf.@Yr1	Module performance in Year 1	%	0.00 ÷ 100.00	90
Perf.@Yr2	Module performance in Year 2	%	0.00 ÷ 100.00	80
Years@Perf.1	Performance Year 1	Years	0.0 ÷ 50.0	10
Years@Perf.2	Performance Year 2	Years	0.0 ÷ 50.0	25
Type	Module type: STD (Monofacial) BIFAC. (Bifacial)	-	-	STD
Coef. Bif.	Isc/Pmax bifaciality factor	%	0.00 ÷ 100.00	79.0
PhiTollBi	Isc/Pmax bifaciality factor tolerance	%	0.00 ÷ 100.00	16.0

Table 1: Typical parameters of PV modules

CAUTION



- The parameters "**Perf.@Yr1**" and "**Perf.@Yr2**" represent the module performance percentages declared in the manufacturer's data sheet
- The "**Years@Perf.1**" and "**Years@Perf.2**" parameters represent the years of operation of the module to which the manufacturer has assigned the performance associated with the "**Perf.@Yr1**" and "**Perf.@Yr2**" parameters
- On the basis of these values, the instrument automatically calculates the Years/Performance curve (see Fig. 23) from which to derive the performance loss control value % used to calculate the I-V curve (see § 6.4.5)

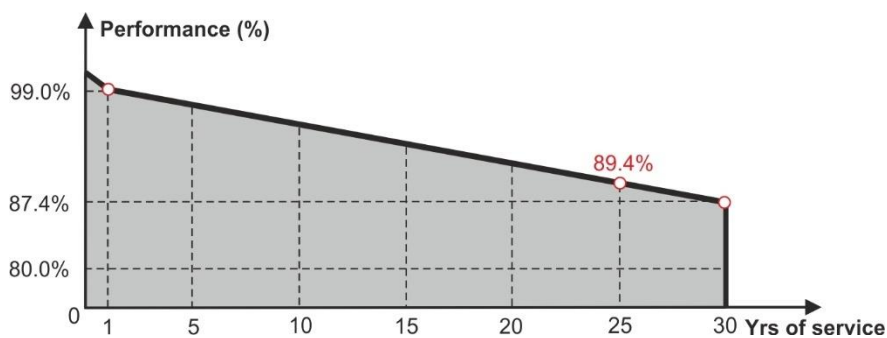

Fig. 23: Example of the Years/Performance curve of a PV module

The initial screen of the Database function is shown in the following Fig. 24:



Fig. 24: Database function initial screen



in which there are two sections:

Left-hand side

- The list of PV module manufacturers in alphabetical order, as entered by the user (manually or via the management software HTAgorà) up to that point. A manufacturer is selected
- The list of PV modules in alphabetical order associated with the selected manufacturer, as entered by the user (manually or via the management software HTAgorà) up to that point

Right-hand side

- List of parameters corresponding to the currently selected module. The list normally comprises several pages → **scroll up/down to view all the parameters**

Tap on the  icon to select the currently highlighted PV module and use it for testing, or on the  icon to exit and return to the main menu

6.3.1. How to define a new PV module

1. Tap on the "New" button on the main screen to open the programming screen. The following window will appear on the display:

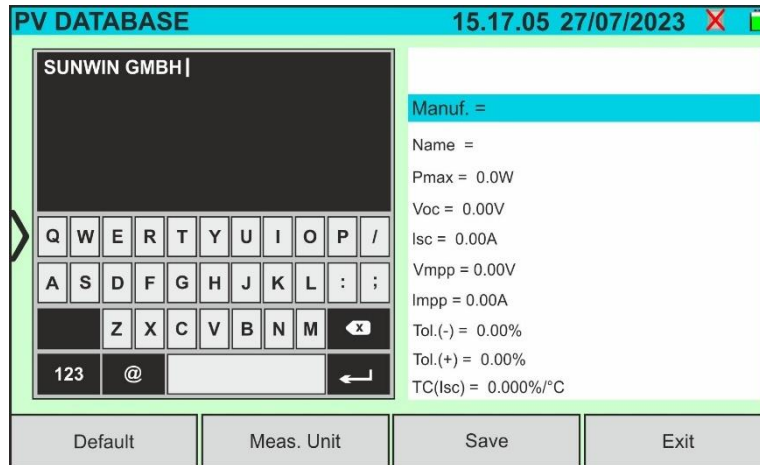

Fig. 25: Creating a new PV module - Step 1

2. Use the alphanumeric virtual keyboard to set the name of the manufacturer and the model. Tap on the (ENTER) button on the virtual keyboard to confirm each value and move on to the next item
3. Use the virtual numeric keypad to set the parameter values for the module according to the module data sheet, as shown in Fig. 26.
4. **If certain parameters are unknown**, tap on the "Default" key to enter the corresponding default value present in Table 1 (**these values may also not be correct for the module being tested, so please contact the PV module manufacturer if necessary**)
5. Use the "Meas. Unit" key. to select the measurement unit of the tolerance associated to the power between the "%" or "W" options
6. Tap on the (ENTER) button on the virtual keyboard to confirm each value and move on to the next item

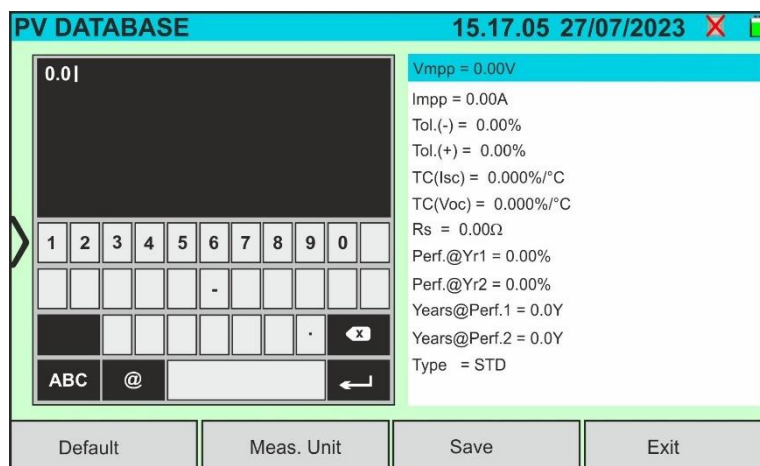

Fig. 26: Creating a new PV module - Step 2

4. Scroll the display up/down to view all the parameters. For the "Type" parameter, scroll the thumb wheel to the right or left to set the PV module type (see Fig. 27). The following options are available:

- **STD** → Standard Module (Monofacial)
- **Bifacial_** → Bifacial Module

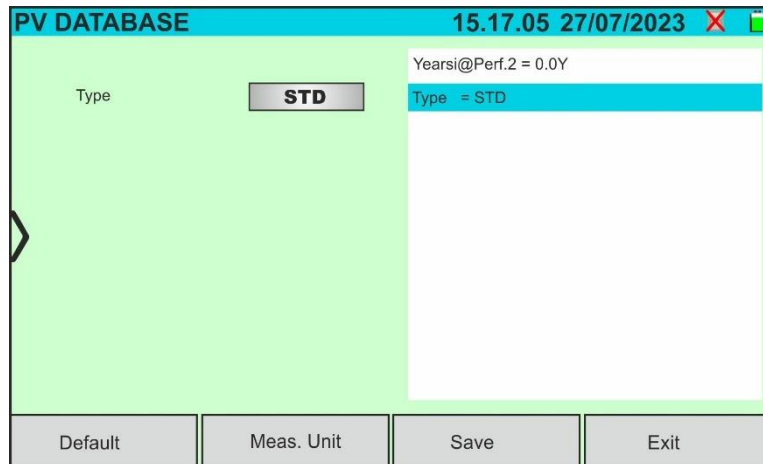

Fig. 27: Creating a new PV module - Step 3

5. Tap on the **"Save"** key to save the defined module and return to the main screen, or tap on the **"Exit"** key to exit the setting without saving

6.3.2. Modification of a PV module

1. Tap on the **"Edit"** key on the main screen. The following window will appear on the display:

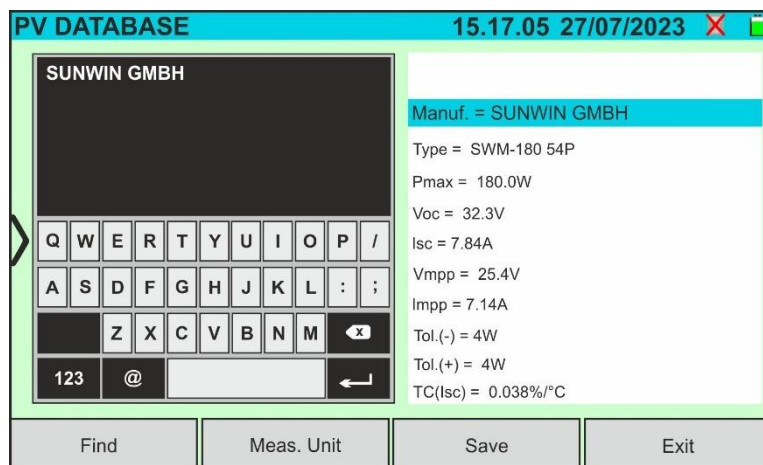

Fig. 28: Modification of an existing module

2. Use the virtual alphanumeric keyboard to change the parameters. Tap on the (ENTER) button on the virtual keyboard to confirm each value and move on to the next item
3. Tap on the **"Save"** key to save the changes and return to the main screen, or tap on the **"Exit"** key to exit the setting without saving



CAUTION

It is not possible to change the name of the manufacturer

6.3.3. Searching for PV modules in the database



CAUTION

The search performed by the instrument is **positional**, i.e. the string entered will be searched within the lists starting from the first character to the left

1. Tap on the "**Find**" key on the main screen. The following window will appear on the display:

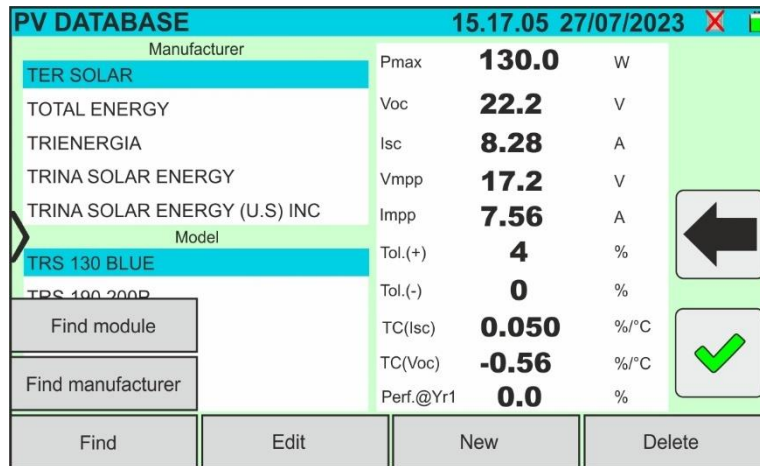

Fig. 29: Searching for a module in the database

2. Tap on the "**Find module**" option to perform a search by module in the database. The following screen will appear on the display:



Fig. 30: Search by module

3. Use the alphanumeric virtual keyboard to enter the desired model name or a keyword and tap on **ENTER** (ENTER) on the virtual keyboard to confirm. The searched model (if present) will be highlighted on the display (see Fig. 30)
4. Tap on the "**Find manufacturer**" option to perform a search by manufacturer in the database. The following screen will appear on the display:



Fig. 31: Search by manufacturer

5. Use the alphanumeric virtual keyboard to enter the desired manufacturer's name or a keyword and tap on  (ENTER) on the virtual keyboard to confirm. The searched manufacturer (if present) will be highlighted on the display (see Fig. 31)

6.3.4. Deleting a PV module

1. With the PV module highlighted in the main screen, tap on the "Delete" key. The following window will appear on the display:

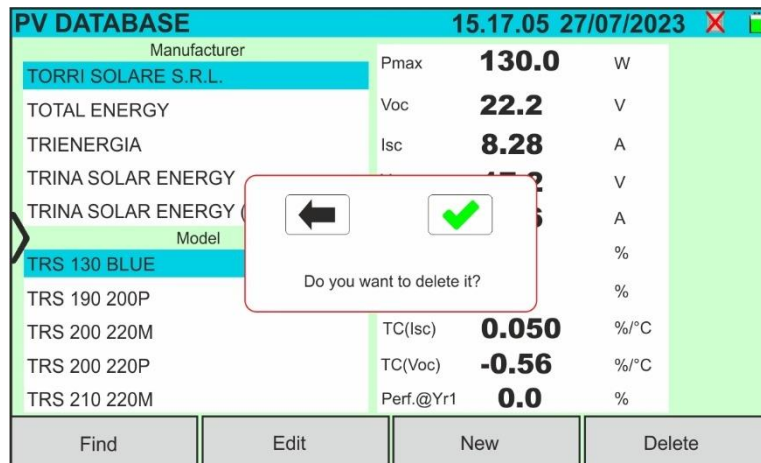



Fig. 32: Deleting a PV module

2. Tap on the  key to confirm. The highlighted module will be removed from the database; alternatively, tap on the  key to exit without proceeding

6.3.5. Restore PV modules database

If the PV modules database saved on the instrument is corrupt and is no longer accessible due to improper operations by the user or internal damages, it is possible to **restore the factory database (default)** in order to continue with the measurements. To this end, proceed as follows:

1. Tap on the “**Settings**” in the general menu
2. Tap on the “**Reset Database**” key. The following message is shown on the display:

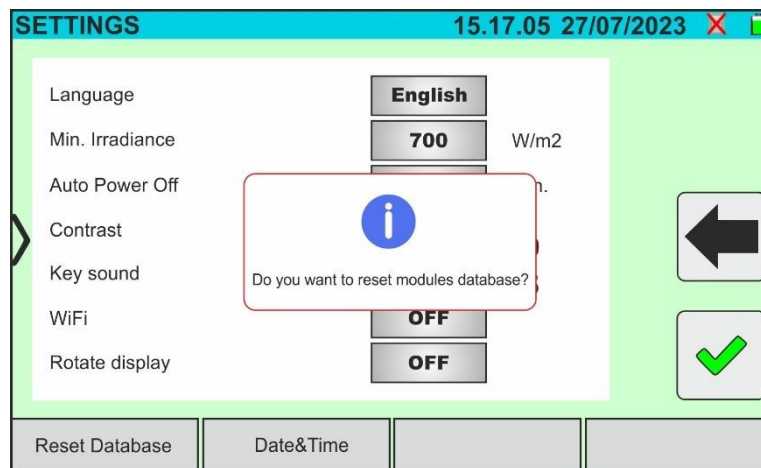

Fig. 33: Reset PV modules database

3. Tap on the key to confirm or the key to exit without proceeding



CAUTION

- The “**Reset Database**” command **permanently deletes** all the modules saved in the instrument database
- The restore of deleted modules could be possible via connection to a PC (see § 8) if the modules had been saved within the HTAgorà management software

6.4. I-V – MEASURING THE I-V CURVE

6.4.1. General information

The instrument allows measuring the I-V curve on PV modules/strings/fields (see § 11.1) in the following modes:

- **SOLAR03 remote unit NOT connected** → In this case the instrument does not receive any irradiation and temperature measurements and provides ONLY the parameter values at @OPC conditions as a result without any outcome to **quickly** evaluate only the trend of the curve to understand any situations environmental on the PV field (shading, mismatch, etc.). **Any post-processing of the data can be carried out with the HTAgorà management software.** See § 6.5.2 for connection methods
- **SOLAR03 remote unit connected (recommended test)** → In this case the instrument receives the irradiation and temperature measurements and provides the **complete** numerical results and curves at @STC conditions. Irradiance measurements are performed via one or more **HT305** reference cells (**in the case of Bifacial modules**) connected to the SOLAR03 remote unit



CAUTION

For the irradiation measurements carried out with the **HT305** reference cell(s) **it is not necessary** to set the relative sensitivity and alpha values which are **automatically** managed by the SOLAR03 after connecting these accessories to this remote unit

The I-V600 instrument can acquire the module temperature value (also **essential** for calculating values under @STC conditions) as follows:

- **"Meas."**: temperature measured via the **PT305** probe connected to SOLAR03
- **"Auto"**: temperature calculated by the instrument on the basis of the measured open circuit voltage V_{oc} and the nominal parameters of the module

In general, the instrument and the SOLAR03 unit can operate in the following modes:

- Instrument used in **Bluetooth direct connection** with SOLAR03 remote unit **without recording of** irradiance/temperature values
- Instrument used in direct connection with the SOLAR03 remote unit **with prior start of synchronous recording of** irradiance/temperature values. If the connection between the instrument and the remote unit is critical (long distance or transmission through walls/obstacles), the irradiance values (and temperature, if selected) will be transmitted at the end of the session by bringing the two units closer together and stopping recording

The Current/Voltage value pairs describing the I-V curve are initially acquired under **OPC conditions (Operative Conditions)**, i.e. under the actual conditions of the plant. Using the irradiance/temperature values, the instrument then automatically converts these pairs to **STC conditions (Standard Test Condition - Irradiance = 1000W/m², Module Temperature = 25 °C, Spectral Distribution AM=1.5)** for comparison with the nominal characteristics declared by the module manufacturer (and stored in the instrument's internal database).

6.4.2. I-V Curve test without remote unit SOLAR03



CAUTION

- The maximum voltage between the P1, C1, P2 and C2 inputs is 1500VDC. Do not measure voltages exceeding the limits given in this manual.
- Do not perform tests on PV modules or strings connected to the DC/AC converter.
- **The maximum current measured by the instrument is 40A**
- Standard IEC/EN62446-1 requires that measurements are performed string by string. Even if the instrument is designed to handle inrush current for single strings or strings connected in parallel, we recommend testing **one string at a time** in accordance with the standard.

1. Switch on the instrument by pressing the **ON/OFF** key
2. Note the presence of the "X" in the top right corner of the display to indicate the absence of an active SOLAR03 remote unit connected to the instrument. If not, execute the "**Unpair**" command for the currently active unit (see § 6.2)
3. Connect the instrument to the module/string being tested as shown in Fig. 34. In particular, connect the Negative pole of the module/string to the **P2, C2** terminals and the Positive pole from the module/string to the **P1, C1** terminals

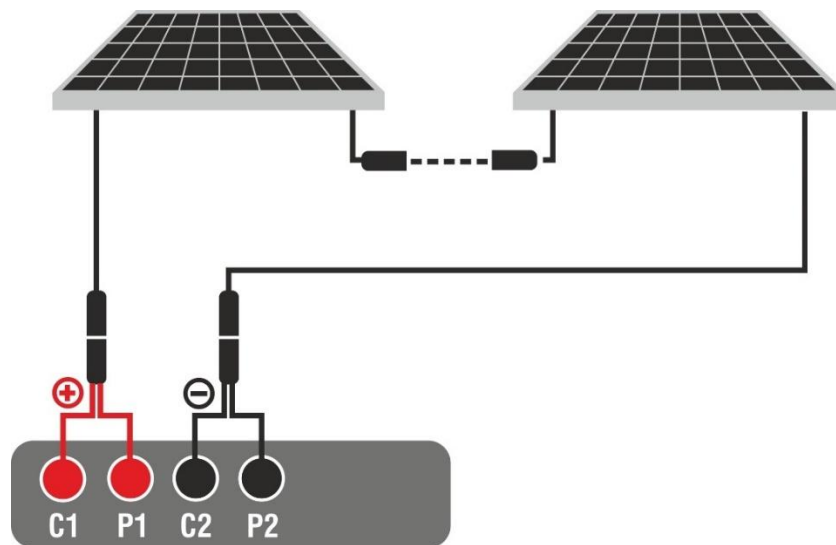

Fig. 34: Connection for I-V test without remote unit SOLAR03

4. In the case of **Monofacial** modules, the screen of Fig. 35 is shown on the display. The following parameters are indicated:
 - VPN voltage between positive and negative pole of the string
 - Module temperature with "- -" indication as remote unit not connected
 - Module irradiance with "- -" indication as remote unit not connected
 - Display of currently selected PV module
 - References of **C1, P1, C2, P2** terminals connected to the instrument

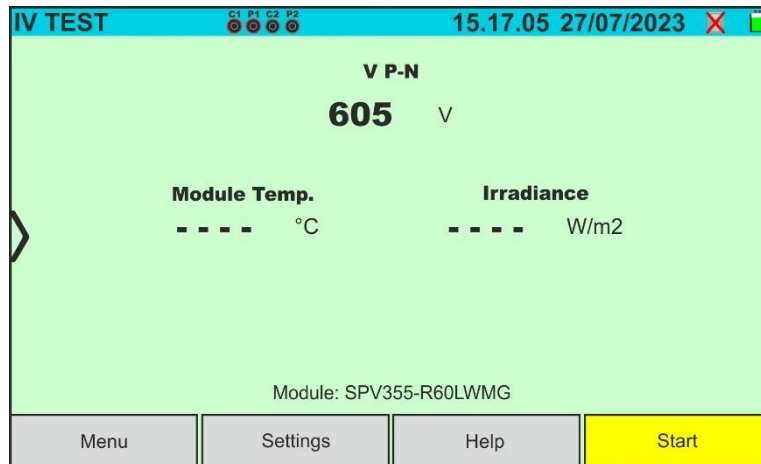

Fig. 35: Initial I-V test screen without remote unit on Monofacial modules

5. In the case of **Bifacial** modules, the screen of Fig. 36 is shown on the display. The following parameters are indicated:

- VPN voltage between positive and negative pole of the string
- Module temperature with "-" indication as remote unit not connected
- Irradiance of the front with "-" indication as remote unit not connected
- Irradiance of the back with "-" indication as remote unit not connected
- Display of currently selected PV module
- References of **C1, P1, C2, P2** terminals connected to the instrument

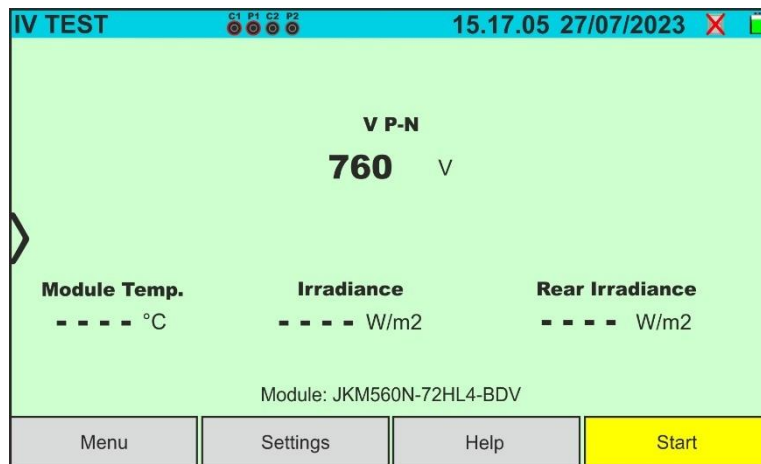



Fig. 36: Initial I-V test screen without remote unit on Bifacial modules

6. Tap on the **"Settings"** key (Monofacial module reference). The following screen is shown in Fig. 59. The following parameters are given:

- Reference values of the currently selected module
- Parameters of the test string to be programmed
- Icon  to save the settings and return to the main screen, or icon  to exit without saving

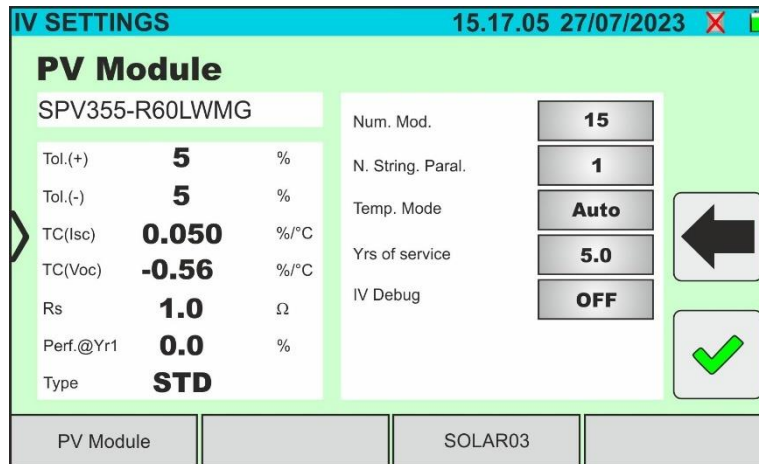

Fig. 37: Settings parameters I-V test without remote unit

7. Tap on the "PV Module" key to change the PV module to be tested. The instrument opens the DB section, where a new module can be selected from the list in the DB section (see § 6.3)
8. Drag each of the 5 available thumb wheels to the right or left to set the desired value of the following parameters:
 - **Num. Mod** → to set the number of modules in the string being tested (**max. 60**)
 - **N. String Paral.** → to set the number of strings in parallel (**max. 5**). Setting "1" indicates the presence of only one overall string
 - **Temp. Mode** → to set the module temperature measurement mode. The following options are available: **Auto** (temperature calculated by the instrument based on the Voc measurement and the nominal parameters of the module- **no probe connected and recommended option**), **Meas.** (temperature measured via PT305 probe connected to the SOLAR03 remote unit)
 - **Yrs of service** (setting the number of years of operation of the PV system being tested in the range **0.1 ÷ 49.9** years with 0.1-year increments), considering that **0.5 years = 6 months**. This information is used by the instrument to determine the I-V curve
 - **IV Debug** → this function **must only be used in operations with the HT assistance service**. The option **MUST** always be set to **OFF**

CAUTION





- When **START/STOP** (or **Start** on the display) is pressed, the instrument may give various error messages (see § 6.4.6) and, as a result, fail to perform the test. Check and, if possible, eliminate the cause of the problem before proceeding.
- The method used by the instrument meter for output VDC and IDC measurements of PV module/string is the "4-wire". Therefore, it is possible to use also test cables connected to P1, C1, P2, C2 inputs of different length without performing any calibration of cable resistance. **For extensions, only use accessories supplied by HT**

9. Press the **START/STOP** key (or **Start** on the display) to activate the tests. If there are no error conditions, the instrument will show the icon "⌚" on the display for a few moments together with the message "**Measuring...**" The test can take **up to approximately 20 seconds**, depending on the open circuit voltage and module parameters. In the absence of a direct connection to the SOLAR03 unit, the instrument will show **only the measured values @OPC without the irradiance and module temperature references** (see Fig. 38) **and without final result**



Fig. 38: I-V curve measurement result without remote unit

10. Tap on  to save the measurement (see § 7.1) or the icon  to exit without saving

6.4.3. I-V Curve test with remote unit SOLAR03 in direct connection



CAUTION

- The maximum voltage between the P1, C1, P2 and C2 inputs is 1500VDC. Do not measure voltages exceeding the limits given in this manual.
- Do not perform tests on PV modules or strings connected to the DC/AC converter.
- **The maximum current measured by the instrument is 40A**
- Standard IEC/EN62446-1 requires that measurements are performed string by string. Even if the instrument is designed to handle inrush current for single strings or strings connected in parallel, we recommend testing **one string at a time** in accordance with the standard.

1. Switch on the instrument by pressing the **ON/OFF** key
2. Switch on the SOLAR03 remote unit, pair it with and connect it to the instrument as described in § 6.2. Note the presence of the "📶" icon in the top right corner of the display
3. Connect the instrument and the SOLAR03 remote unit to the module/string being tested as shown in Fig. 39. In detail:

- Connect the Negative pole output of the module/string to terminals **P2, C2** and the Positive pole output of the module/string to terminals **P1, C1**
- **In case of Monofacial modules** → position the reference cell **HT305** onto the front surface of module (**F**) and at input "INP1" and **possibly** temperature probe **PT305** at input "INP4" of the remote unit.
- **In case of Bifacial modules** →, position the **three HT305 reference cells** on the front surface of module (**F**), on the top back section (**BT=BackTop**) and on the bottom back section (**BB=BackBottom**) of the module. Connect the front reference cell (F) to input "INP1", BT reference cell to input "INP2", BB reference cell to input "INP3" and **possibly** the temperature probe **PT305** to input "INP4" of the remote unit.

In accordance with the IEC/EN60904-1-2 standard, the instrument calculates the equivalent front-side Irradiance (**Irreq**) value, which corresponds to the Irradiance on the front surface only, which produces the same effects as the Irradiance measured on both sides, considering the **bifaciality factor** (φ) of the module according to the following relationship:

$$Irr_{Eq} = Irr_F + \varphi \times Irr_R$$

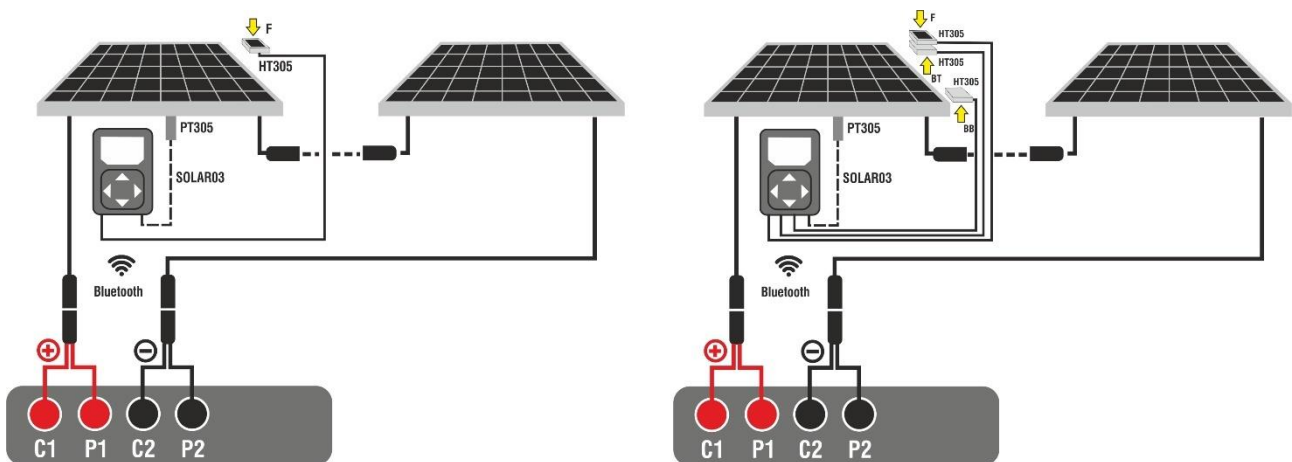

Fig. 39: Connection with remote unit SOLAR03 on Monofacial and Bifacial modules

4. In the case of **Monofacial** modules, the Fig. 40 screen is present on the display. The following parameters are shown:

- VPN voltage between positive and negative pole of the string
- Module temperature (**with PT305 probe connected**)
- Module irradiance measured by reference cell HT305
- Display of currently selected PV module
- References of **C1, P1, C2, P2** terminals connected to the instrument

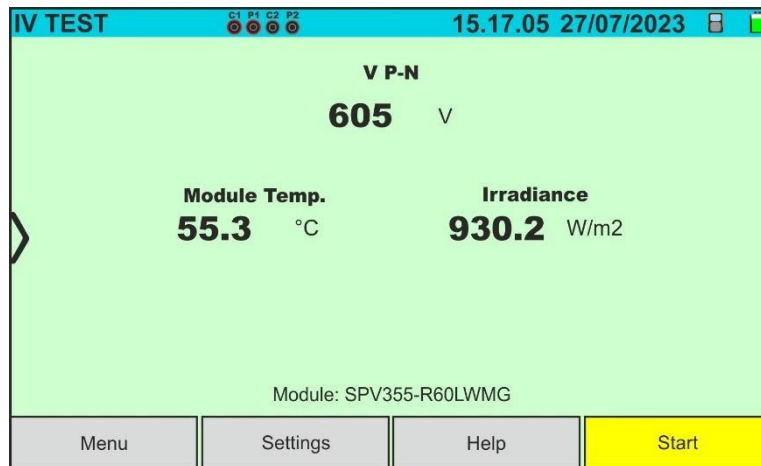

Fig. 40: Initial I-V curve measurement screen on Monofacial modules

5. In the case of **Bifacial** modules, the screen Fig. 41 is present on the display. The following parameters are shown:

- VPN voltage between positive and negative pole of the string
- Module temperature (**with PT305 probe connected**)
- Irradiance of the front side of the module measured by reference cell HT305
- Irradiance of the back side of the module measured by reference cells HT305



CAUTION

The "**Rear Irradiance**" parameter indicates the **minimum value** between the irradiance measured by the HT305 cells at the bottom back (BB) and top back (BT) of the module

- Display of currently selected PV module
- References of **C1, P1, C2, P2** terminals connected to the instrument

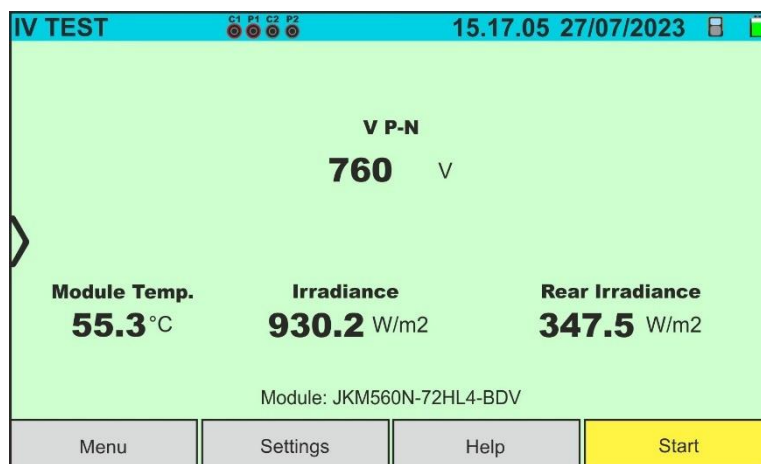

Fig. 41: Initial I-V curve measurement screen on Bifacial modules

6. Tap on the **"Settings"** key (Monofacial module reference). The following screen is shown in Fig. 42. The following parameters are given:



- References of the currently selected module
- Parameters of the test string to be programmed
- Icon  to save the settings and return to the main screen, or icon  to exit without saving



Fig. 42: I-V curve measurement parameter settings

7. Tap on the **"PV Module"** key to change the PV module to be tested. The instrument opens the DB section, where a new module can be selected from the list in the DB section (see § 6.3)

3. Drag each of the 4 available thumb wheels to the right or left to set the desired value of the following parameters:

- **Num. Mod** → to set the number of modules in the string being tested (**max. 60**)
- **N. String Paral.** → to set the number of strings in parallel (**max. 5**). Setting "1" indicates the presence of only one overall string
- **Temp. Mode** → to set the module temperature measurement mode. The following options are available: **Auto** (temperature calculated by the instrument based on the Voc measurement and the nominal parameters of the module- **no probe connected and recommended option**), **Meas.** (temperature measured via PT305 probe connected to the SOLAR03 remote unit)
- **Yrs of service** (setting the number of years of operation of the PV system being tested in the range **0.1 ÷ 49.9** years with 0.1-year increments), considering that **0.5 years = 6 months**. This information is used by the instrument to determine the I-V curve
- **IV Debug** → this function **must only be used in operations with the HT assistance service**. The option **MUST** always be set to **OFF**

8. Tap on the **"SOLAR03"** key to access the control and management section of the SOLAR03 remote unit (see § 6.2). Check that the remote unit is active and connected to the instrument

9. Check that the value set in the "Min. Irradiance" section (see § 5.2) is consistent with the measurements to be taken. It is recommended to measure with a threshold of **≥ 700 W/m²** in accordance with the IEC/EN60891 standard.

10. Assemble the stem onto the disk of the accessory **M304** and keep it resting on the module's surface. **Check that the shadow of the stem on the disk falls within the internal "limit concentric circle" of the disk itself (see picture).** If this is not the case, the angle between the sun's rays and the module surface is too high and therefore the measurements taken by the instrument are NOT reliable. **Repeat the operations at other times of the day**

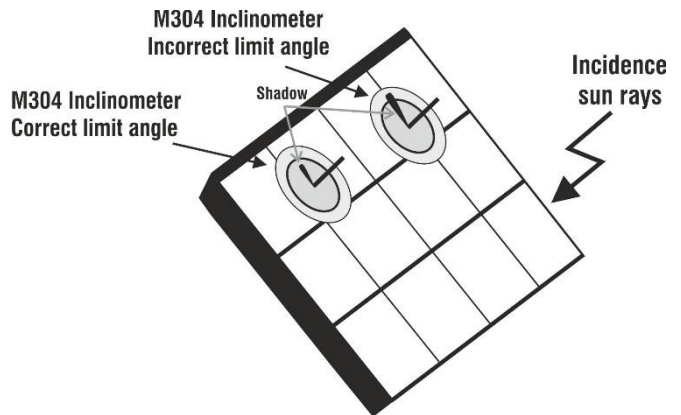

CAUTION





- When **START/STOP** (or **Start** on the display) is pressed, the instrument may give various error messages (see § 6.4.6) and, as a result, fail to perform the test. Check and, if possible, eliminate the cause of the problem before proceeding.
- The method used by the instrument meter for output VDC and IDC measurements of PV module/string is the "4-wire". Therefore, it is possible to use also test cables connected to P1, C1, P2, C2 inputs of different length without performing any calibration of cable resistance. **For extensions, only use accessories supplied by HT**

11. Press the **START/STOP** key (or **Start** on the display) to activate the test. If there are no error conditions, the instrument will show the icon "⌚" on the display for a few moments together with the message "**Measuring...**" The test can take **up to approximately 20 seconds**, depending on the open circuit voltage and module parameters. At the end of the test, **the values related to the @STC conditions**, and the corresponding result are displayed (here below, for convenience, only Monofacial modules are referred to (the results for bifacial modules are similar as they refer to the equivalent front-side Irradiance



Fig. 43: Example of I-V curve measurement result - STC values

12. The measurement result screen shows the following parameters:

- Nominal values of the module being tested under **STC conditions** as defined in the internal DB (see § 6.3)
- Measurement results calculated under STC conditions as a function of irradiance values measured by the connected SOLAR03 remote unit
- Indication of the value of the parameter $\Delta p\%$ in compliance with the control conditions shown in § 6.4.5
- Icons , , ,  to indicate the result of the measurement

13. The following additional results can be viewed by scrolling left or right. **Results under OPC conditions:** the following screen appears on the display:



Fig. 44: Example of I-V curve measurement result - OPC values

14. The measurement result screen shows the following parameters:

- Values of the test parameters set in the main screen (number of modules, number of strings in parallel, years of operation and annual performance percentage)
- Measurement results of electrical and environmental parameters (irradiance and module temperature) under OPC conditions

15. **Graphs of I-V and power curves under OPC and STC conditions.** Examples of screens are shown in the following figures

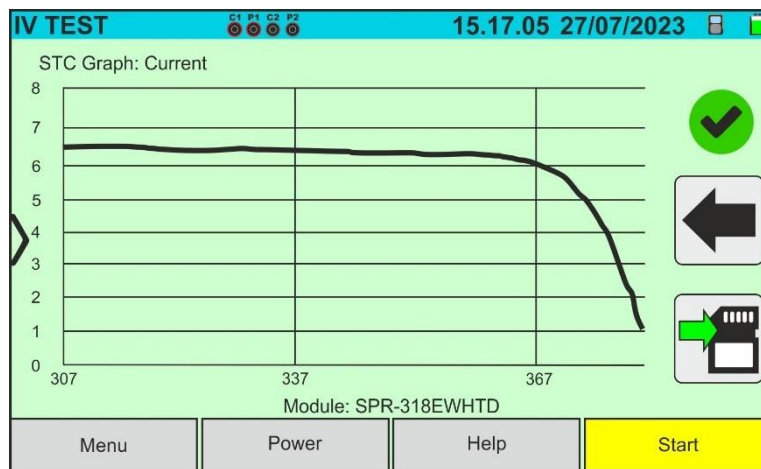

Fig. 45: Example of I-V curve measurement result - STC curve

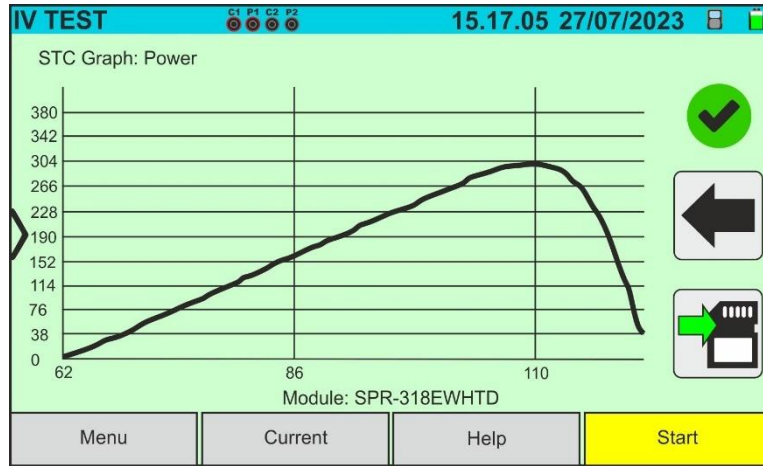

Fig. 46: Example of power measurement result - STC curve



CAUTION

- The instrument refers all the values to **one module only** under STC condition
- The string voltage obtained at OPC indicates the total measured value. Together with the measured current, the instrument calculates the I-V curve @ OPC which is then translated to the @STC conditions

16. Tap on the icon to save the measurement result (see § 7.1) or on the icon to exit without saving

6.4.4. I-V Curve test with remote unit SOLAR03 in synchronous recording

Irradiance and temperature measurements (if the instrument is set to temperature measurement mode "Meas.") **via SOLAR03 remote unit in synchronous recording** are recommended if the distance between the modules and the instrument is significant. On the other hand, since it is impossible for the instrument to obtain the above environmental values immediately, it is necessary to wait for the data to be transmitted from the remote unit to the main unit to have all the available results.



CAUTION

- The maximum voltage between the P1, C1, P2 and C2 inputs is 1500VDC. Do not measure voltages exceeding the limits given in this manual.
- Do not perform tests on PV modules or strings connected to the DC/AC converter.
- **The maximum current measured by the instrument is 40A**
- Standard IEC/EN62446 requires that measurements are performed string by string. Even if the instrument is designed to handle inrush current for single strings or strings connected in parallel, we recommend testing **one string at a time** in accordance with the standard.

1. Switch on the instrument by pressing the **ON/OFF** key
2. Connect the instrument to the module/string being tested as shown in Fig. 47 (Monofacial modules) or Fig. 48 (Bifacial modules). In detail, connect the negative pole output of the module/string to terminals **P2, C2** and the positive pole output of the module/string to terminals **P1, C1**

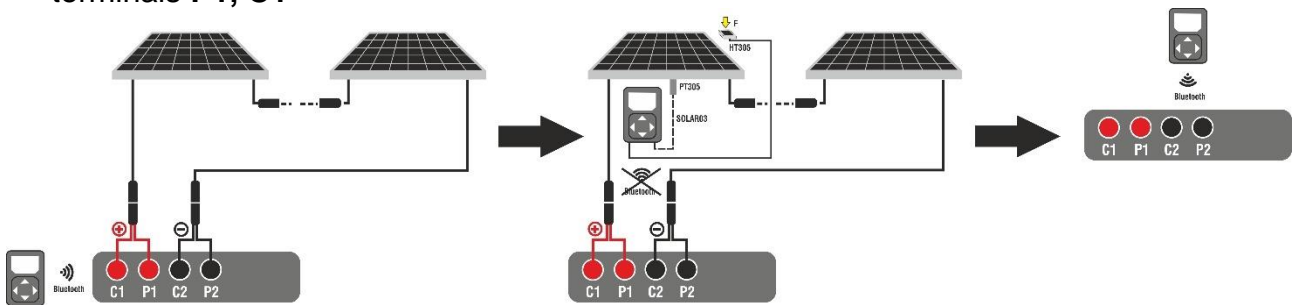

Fig. 47: Connection with SOLAR03 in synchronous recording on Monofacial modules

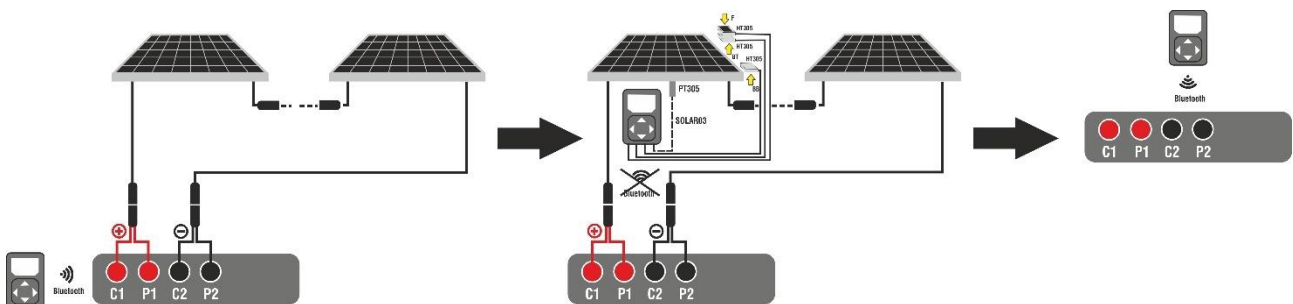

Fig. 48: Connection with SOLAR03 in synchronous recording on Bifacial modules

Step 1

3. Move the SOLAR03 remote unit close to the instrument as shown in Fig. 47 or Fig. 48 – left side part

4. Tap on the "**SOLAR03**" key to access the control and management section of the SOLAR03 remote unit (see § 6.2). Check that **only one** remote unit is active and connected to the instrument
5. Tap on the "**Run/Stop**" key to start recording on the connected remote unit; the following screen will be displayed:

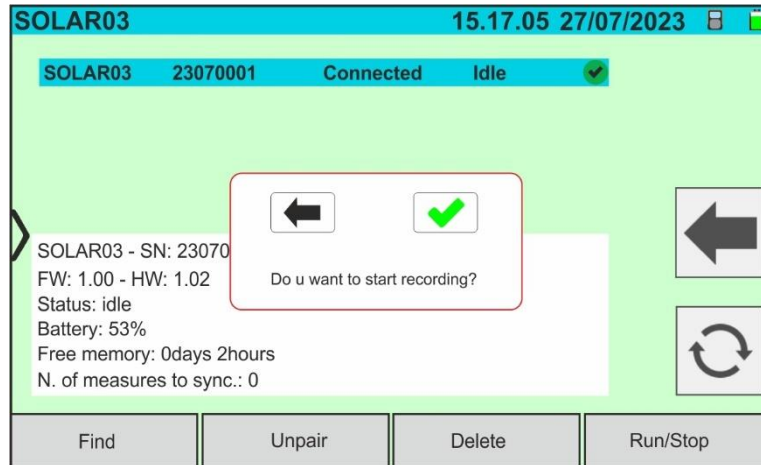

Fig. 49: Recording Activation on Remote Unit - Step 1

6. Tap on to confirm or tap on to exit without proceeding. Recording is performed with a **1s non-editable scan** and the message "**REC**" appears on the remote unit display to indicate the operation in progress

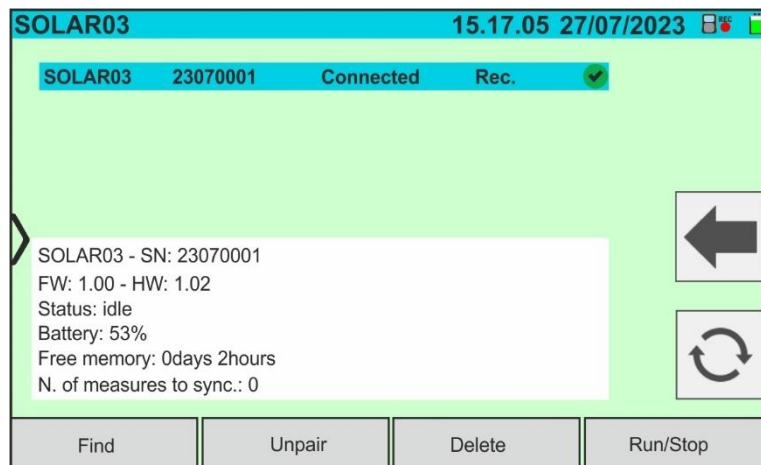



Fig. 50: Recording Activation on Remote Unit - Step 2

7. The  icon and the message "**Rec.**" are shown on the display and the message "REC" is shown on the display of the remote unit

Step 2

8. **Move the remote unit close to the modules** and connect the irradiance and temperature probes (if necessary) as shown in Fig. 47 or Fig. 48 – middle side part. In particular:

- **In case of Monofacial modules** → position the reference cell **HT305** onto the front surface of module (**F**) and at input “**INP1**” and **possibly** temperature probe **PT305** at input “**INP4**” of the remote unit
- **In case of Bifacial modules**→, position the **three HT305 reference cells** on the front surface of module (**F**), on the top back section(**BT=BackTop**) and on the bottom back section (**BB=BackBottom**) of the module. Connect the front reference cell (F) to input “**INP1**”, BT reference cell to input “**INP2**”, BB reference cell to input “**INP3**” and **possibly** the temperature probe **PT305** to input “**INP4**” of the remote unit. In accordance with the IEC/EN60904-1-2 standard, the instrument calculates the equivalent front-side Irradiance (**Irreq**) value, which corresponds to the Irradiance on the front surface only, which produces the same effects as the Irradiance measured on both sides, considering the **bifaciality factor** (φ) of the module according to the following relationship:

$$Irr_{Eq} = Irr_F + \varphi \times Irr_R$$

9. **Since recording has already been activated on remote unit SOLAR03, it is not necessary to maintain the Bluetooth connection anymore.** Maintaining the connection will only allow to immediately obtain the outcome of the test without waiting for the measuring campaign to be completed.

10. In the case of **Monofacial** modules, the Fig. 51 screen is shown on the display. The following parameters are indicated:

- VPN voltage between positive and negative pole of the string
- Module temperature with “- -” indication as the remote unit is not connected
- Module irradiance with “- -” indication as the remote unit is not connected
- Display of currently selected PV module
- References of **C1, P1, C2, P2** terminals connected to the instrument

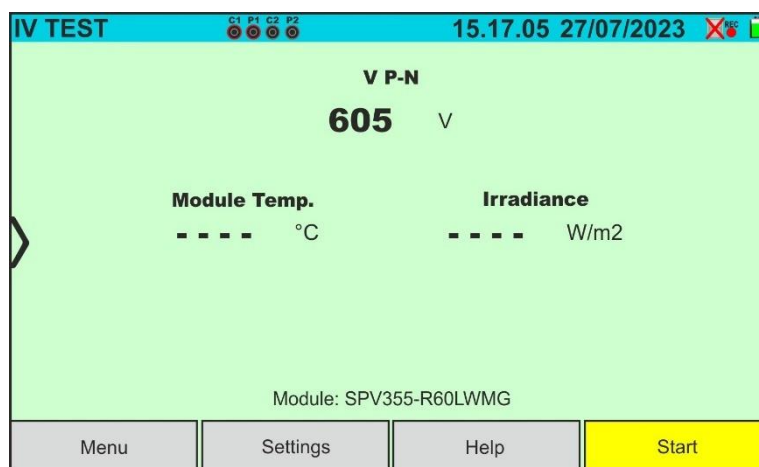

Fig. 51: I-V curve with SOLAR03 in synchronous recording on Monofacial modules

11. In the case of **Bifacial** modules, the screen Fig. 52 is shown on the display. The following parameters are indicated:

- VPN voltage between positive and negative pole of the string
- Module temperature with “- - -” indication as the remote unit is not connected
- Irradiance of the front side with “- - -” indication as the remote unit is not connected
- Irradiance of the rear side with “- - -” indication as the remote unit is not connected



CAUTION

The "**Rear Irradiance**" parameter indicates the **minimum value** between the irradiance measured by the HT305 cells at the bottom back (BB) and top back (BT) of the module

- Display of currently selected PV module
- References of **C1, P1, C2, P2** terminals connected to the instrument

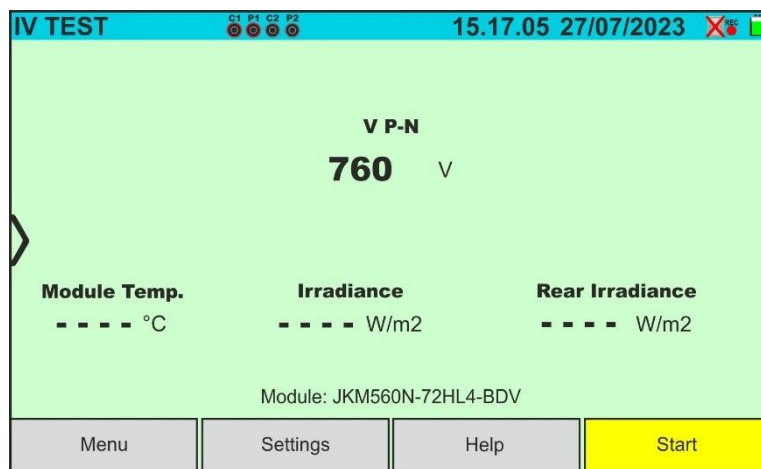

Fig. 52: I-V curve with SOLAR03 in synchronous recording on Bifacial modules

12. Tap on the "**Settings**" key (Monofacial module reference). The following screen is shown in Fig. 42. The following parameters are given:

- References of the currently selected module
- Parameters of the test string to be programmed
- Icon to save the settings and return to the main screen, or icon to exit without saving

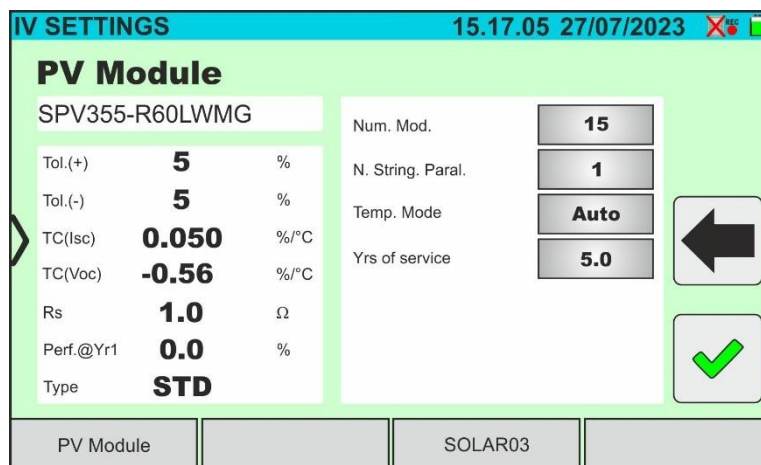
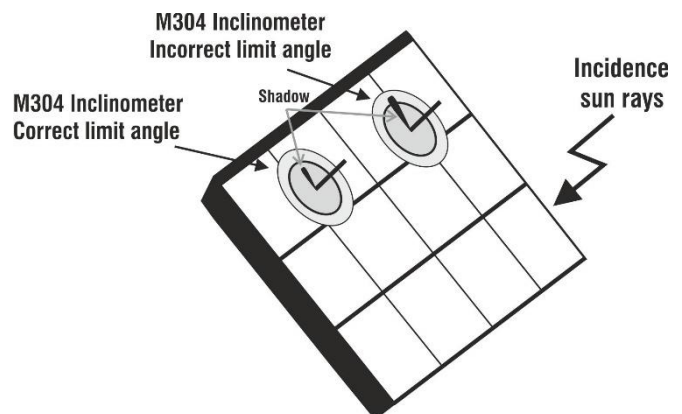

Fig. 53: I-V curve measurement parameter settings

13. Tap on the "**PV Module**" key to change the PV module to be tested. The instrument opens the DB section, where a new module can be selected from the list in the DB section (see § 6.3)
14. Drag each of the 5 available thumb wheels to the right or left to set the desired value of the following parameters:
- **Num. Mod** → to set the number of modules in the string being tested (**max. 60**)
 - **N. String Paral.** → to set the number of strings in parallel (**max. 5**). Setting "1" indicates the presence of only one overall string
 - **Temp. Mode** → to set the module temperature measurement mode. The following options are available: **Auto** (temperature calculated by the instrument based on the Voc measurement and the nominal parameters of the module- **no probe connected and recommended option**), **Meas.** (temperature measured via PT305 probe connected to the SOLAR03 remote unit)
 - **Yrs of service** (setting the number of years of operation of the PV system being tested in the range **0.1 ÷ 49.9** years with 0.1-year increments), considering that **0.5 years = 6 months**. This information is used by the instrument to determine the I-V curve
 - **IV Debug** → this function **must only be used in operations with the HT assistance service**. The option **MUST** always be set to **OFF**

15. Assemble the stem onto the disk of the accessory **M304** and keep it resting on the module's surface. **Check that the shadow of the stem on the disk falls within the internal "limit concentric circle" of the disk itself (see picture).** If this is not the case, the angle between the sun's rays and the module surface is too high and therefore the measurements taken by the instrument are NOT reliable. **Repeat the operations at other times of the day**



CAUTION



- When **START/STOP** (or **Start** on the display) is pressed, the instrument may give various error messages (see § 6.4.6) and, as a result, fail to perform the test. Check and, if possible, eliminate the cause of the problem before proceeding.
- The method used by the instrument meter for output VDC and IDC measurements of PV module/string is the "4-wire". Therefore, it is possible to use also test cables connected to P1, C1, P2, C2 inputs of different length without performing any calibration of cable resistance. **For extensions, only use accessories supplied by HT**
- The settings made on the instrument control parameters can be modified at any time even while recording is in progress

16. Press the **START/STOP** key (or **Start** on the display) to activate the tests. If there are no error conditions, the instrument will show the icon "⌚" on the display for a few moments together with the message "**Measuring...**" The test can take **up to approximately 20 seconds**, depending on the open circuit voltage and module parameters. In the absence of a direct connection to the SOLAR03 unit, the instrument will show **only the measured values @OPC without the irradiance and module temperature references** (see Fig. 54) and final result. To obtain the final result (@STC values) of the tests performed, it is necessary to wait for the end of the test session, the stop of the recording and the **subsequent synchronisation** with the SOLAR03 remote unit.



Fig. 54: I-V curve measurement result @OPC with synchronous recording

17. Tap on the icon to save the measurements to the internal memory (see § 7.1) or on the icon to exit without saving

Step 3

18. **At the end of the test session**, disconnect the SOLAR03 remote unit and move it back close to the instrument (see Fig. 47 or Fig. 48 – right side part)
19. Tap on the "**SOLAR03**" key to access the control and management section of the SOLAR03 remote unit (see § 6.2) and wait for the automatic reconnection to the instrument. The "**N. of measures to sync.**" parameter indicates the value of the stored measurements waiting for values from the SOLAR03 unit.
20. Tap on the "**Run/Stop**" key to **end** the recording. The following screen will appear

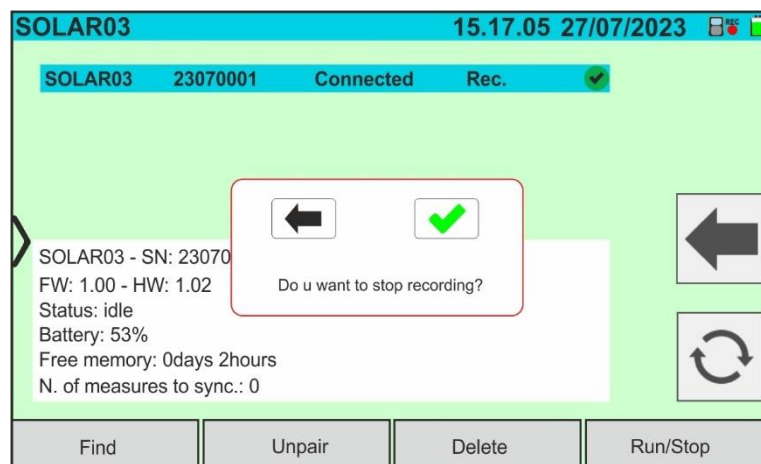





Fig. 55: Ending recording on the remote unit

21. Tap on the  key to confirm or on the  key to exit without proceeding
22. The synchronization of the pending @OPC measurements, the translation of the @STC values and the subsequent saving are performed **automatically** by the instrument. The “**N. of measures to sync**” parameter must take on the value “0” once the operations are completed
23. Tap on the  icon if there are some errors, to reactivate synchronization again
24. Access the memory area (see § 7.2) to retrieve the saved measurements

CAUTION

The instrument translates @OPC results to @STC values when the following conditions occur:

14. Voltage **Voc** > **Voc minimum = 15V**

15. **Frontal** irradiance values (also valid for bifacial modules) detected as greater than the minimum threshold set on the instrument (>100W/m²) and **stable** (variation between the start and end of the measurement campaign **±20 W/m²**)

16. Open voltage Voc measured consistent with expected value indicated in the module datasheet

17. Module temperature value included in the range: **-40°C ÷ 100°C (-40°F ÷ 212°F)**

18. Short-circuit current value **Isc** > **Iscmin = 0.2A**



25. See the § 6.4.5 for the meaning of measurement results

6.4.5. Interpretation of measurement results

The parameter measured and calculated by meter have the following meaning:

Parameter	Description
Pmax	Maximum module power (@STC) measured by the instrument
ΔP%	Difference % of maximum measured power from nominal power (@ STC)
Voc	Open circuit voltage
Vmpp	Voltage on point of maximum power
Isc	Short circuit current
Impp	Current on point of maximum power

Table 2: List of parameter measured by the meter

Where:

$$\Delta P\% = \left(\frac{P_{STC}^{Max} - P_{Perf}^{Nom}}{P_{Perf}^{Nom}} \right) * 100 \rightarrow \text{control parameter that defines the final test result}$$

$$P_{Perf}^{Nom} = P_{Nom} * \left(1 - \frac{PerfLoss\% * YearService}{100} \right) \quad \text{Rated power with performance loss effect (see § 6.3)}$$

P_{Nom} = rated power @STC of the module as declared by the manufacturer

$PerfLoss\%$ = performance loss % calculated based on the data entered in the DB

The following final response is gives by the instrument:

Outcome	Condition	Note
	$-(Tol-) + \epsilon_{Instrum} \leq \epsilon_{Meas} \leq (Tol+) - \epsilon_{Instrum}$	(1)
	Relation (1) is not verified but still applies: $-(Tol-) \leq \epsilon_{Meas} \leq (Tol+)$	(2)
	Relations (1) and (2) are not verified, but still apply: $-(Tol-) - \epsilon_{Instrum} \leq \epsilon_{Meas} \leq (Tol+) + \epsilon_{Instrum}$	(3)
	None of the relations (1), (2) and (3) are verified	(4)

where:

$Tol- = Tol\%(-) * P_{Nom} \rightarrow$ Negative tolerance of the power declared by manufacturer

$Tol+ = Tol\%(+) * P_{Nom} \rightarrow$ Positive tolerance of the power declared by manufacturer

$\epsilon_{Meas} = P_{STC}^{Max} - P_{Perf}^{Nom} \rightarrow$ Control parameter calculated by the instrument

NOTE: the value P_{STC}^{Max} is obtained in compliance with **IEC/EN60891**

$\epsilon_{Strum} \rightarrow$ Maximum instrumental error declared on P(@STC) (see § 10.1)

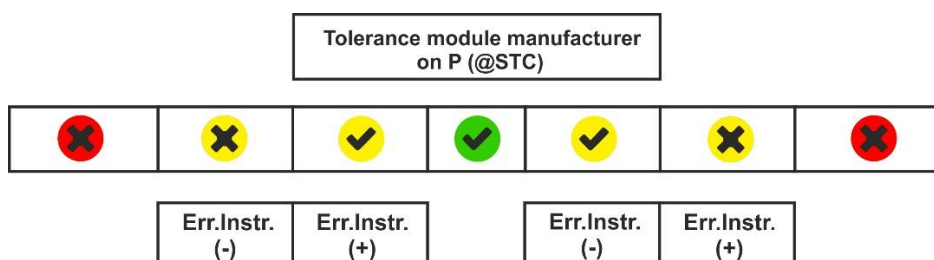

Application example (measurement with remote unit)

- Module name: **JKM575N-72HL4-BDV (JINKO manufacturer)**
- Module type: Bifacial
- Nominal power (@STC): 575W
- Tolerance Power (@STC): -0% / +3%
- Performance loss calculated: 1.3%
- Service year: 1 year
- Measured power (@STC): 547W

$$\text{Tol+} = \text{Tol\%(+)} * P_{\text{nom}} = 0.03 * 575\text{W} = 17.3\text{W}$$

$$\text{Tol-} = \text{Tol\%(-)} * P_{\text{nom}} = 0\text{W}$$

$$P_{\text{Perf}}^{\text{Nom}} = 575 * \left(1 - \frac{1.3 * 1}{100}\right) = 567\text{W}$$

$$\epsilon_{\text{Instrum}} = \pm(547 * 0.04 + 2) = \pm 23.88\text{W}$$

$$\epsilon_{\text{Meas}} = 547 - 567 = -20\text{W}$$

Comparison conditions:

Power $\rightarrow 0 + 23.88 \leq -20 \leq 17.3 - 23.88 \rightarrow$ Condition 1 NOT verified

Power $\rightarrow 0 \leq -20 \leq 17.3 \rightarrow$ Condition 2 NOT verified

Power $\rightarrow -23.88 \leq -20 \leq 17.3 + 23.88 \rightarrow$ Condition 3 verified \rightarrow **Outcome (✘)**

6.4.6. Anomalous situations

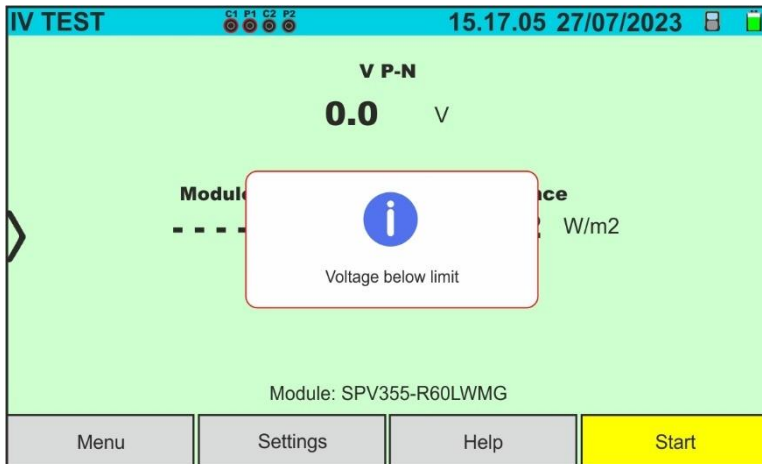

If the instrument detects a voltage of $-0.5V \leq V_{PN} \leq 15VDC$ at the P-N terminals of the string, it does not perform the test, emits a prolonged audible signal and displays the message shown in the screen alongside. Check the tension on the string

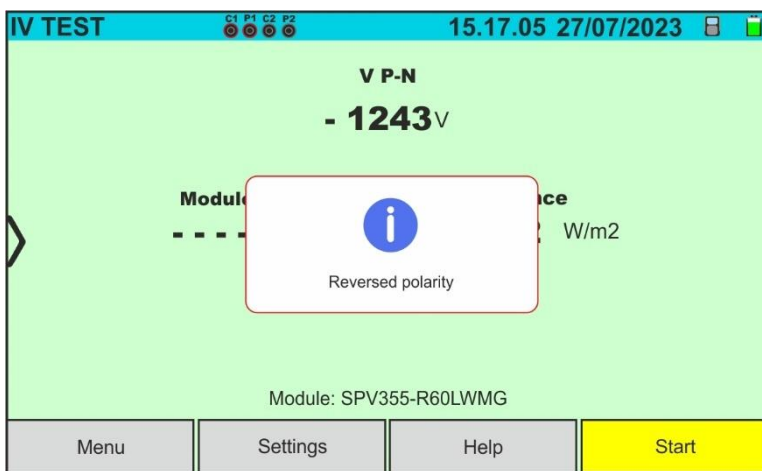

If the instrument detects a voltage $< -0.5VDC$ at the P-N terminals of the string, it does not perform the test, emits a prolonged audible signal and displays the message shown in the screen alongside. Check the connections of the string poles

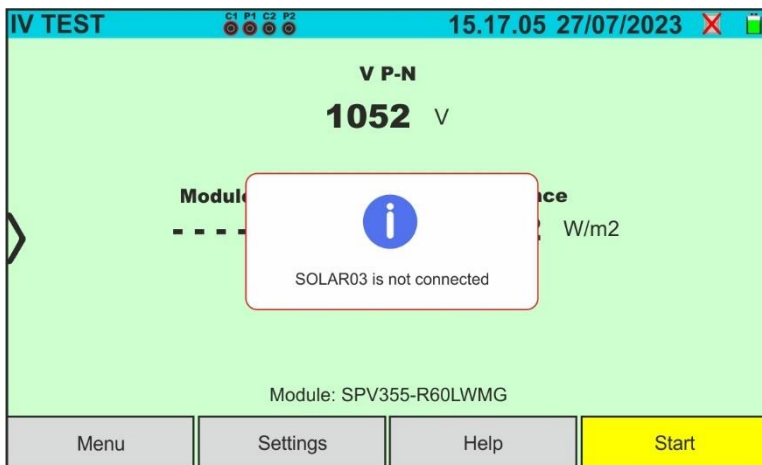

If the SOLAR03 remote unit is active but **not connected and not recording**, the instrument does not perform the test and displays the message shown in the screen alongside. Connect the SOLAR03 remote unit

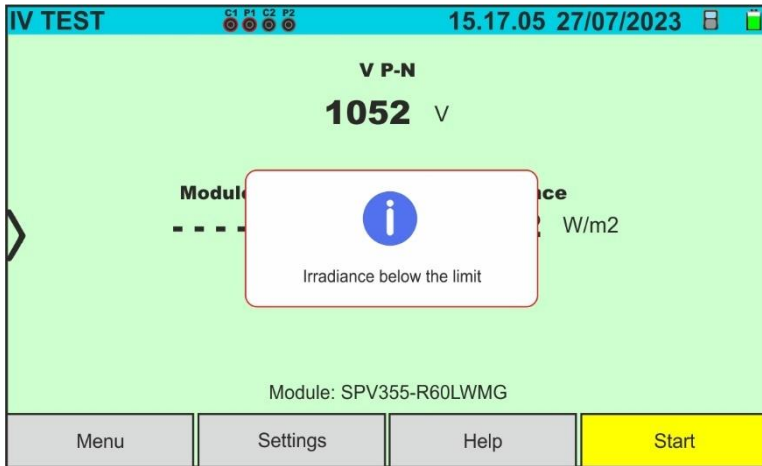

If, with the remote unit active and connected (even in recording mode), the instrument detects an irradiance value below the threshold (see § 5.2), it stops the test and returns to the main screen. Check the threshold value and carry out the tests at another time of the day with stable irradiation

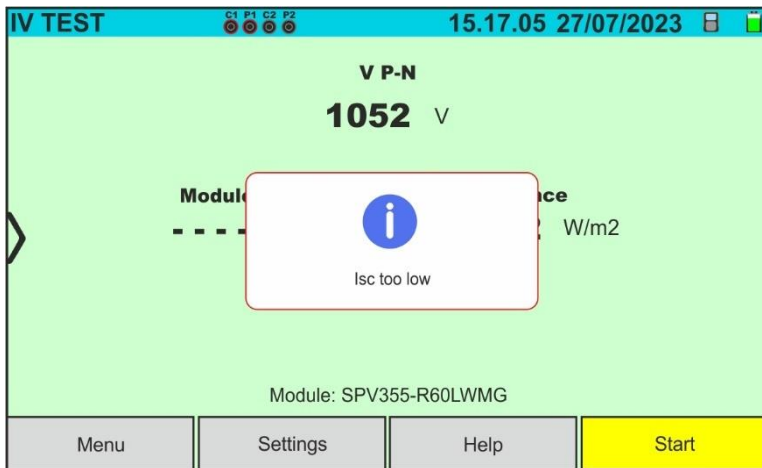

If the instrument detects a short-circuit current **Isc** below a **threshold limit**, it does not perform the test and displays the message shown in the screen alongside. Check the connections of the instrument, the functionality of the module/string, the module settings and the number of modules

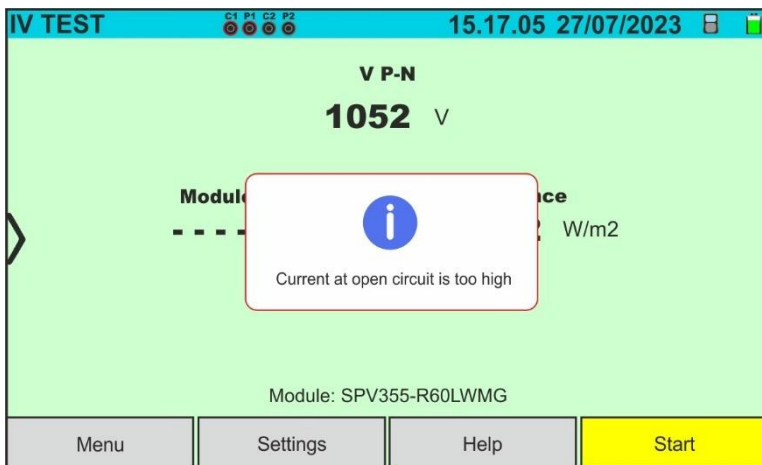

In the I-V curve measurement, if the current detected at the Voc point (no-load situation) is greater than 0.2A, the instrument does not perform the test and displays the message shown in the screen alongside. Check the circuit being measured and repeat the test.

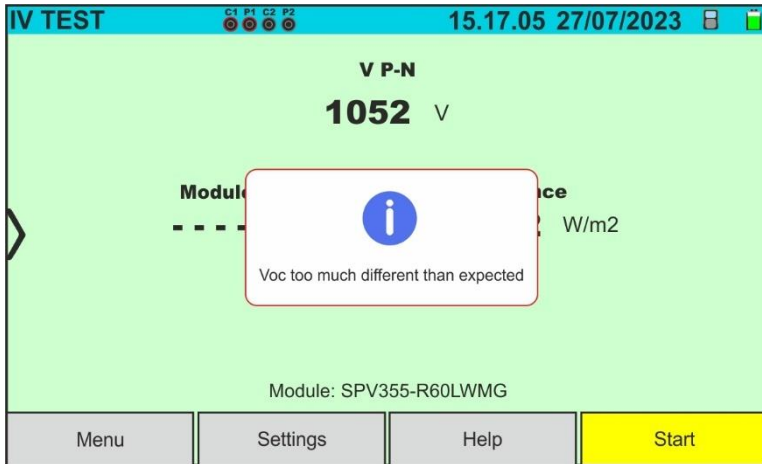

If, during the execution of an I-V or IVCK measurement, the open-circuit voltage (Voc) value is very different from that defined in the module database, the instrument does not perform the measurement and displays the message shown in the screen alongside. Check the values of the Voc, TC(Voc) parameter within the database and the number of modules set in the measurement. With “Auto” selection of the module temperature measurement, wait **approximately 15 minutes** after installing the HT305 cell before start a measurement

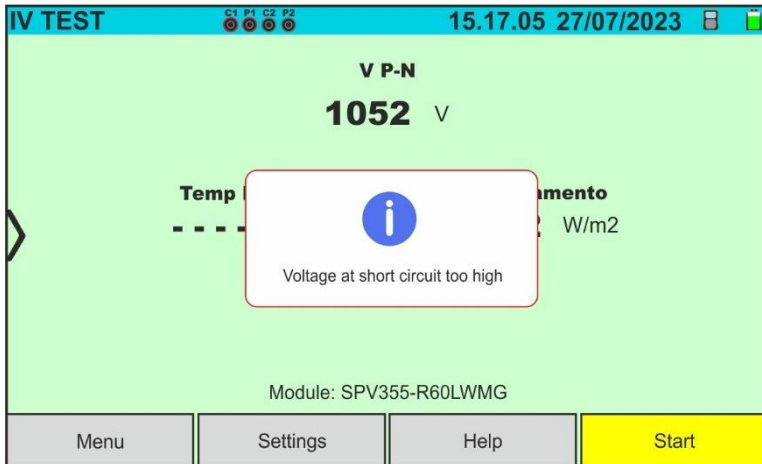

If, during the execution of an I-V or IVCK measurement, the value of the measured voltage is greater than 12%Voc, the instrument does not carry out the measurement and displays the message shown in the screen alongside. Check the circuit being measured and repeat the test

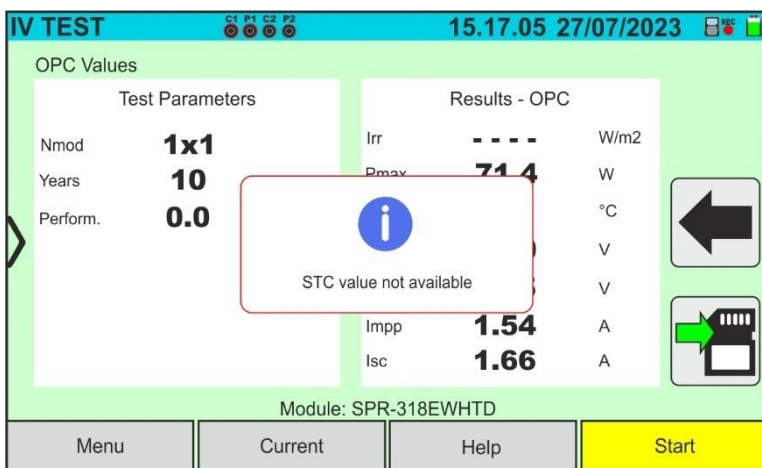

If, during the execution of an I-V or IVCK measurement, the instrument is unable to determine the @STC values, it displays the message shown in the screen alongside. Check that you have stable irradiation, in addition to the correct exceeding of the minimum threshold and that you have carried out the measurement in accordance with the indications of the M304 accessory (see § 6.4.2 – point 10). Repeat the measurements at other times of the day if necessary

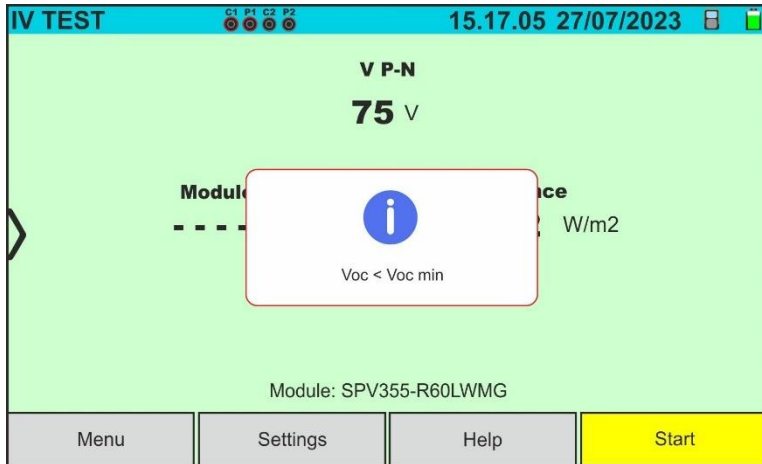

If the instrument detects, at the end of the test, a Voc too much different from the open-circuit voltage measured before starting the test, the message alongside is shown on the display
 This condition could be due to the execution of tests on poor quality modules and/or too low short circuit current and/or measurements carried out with too low irradiance

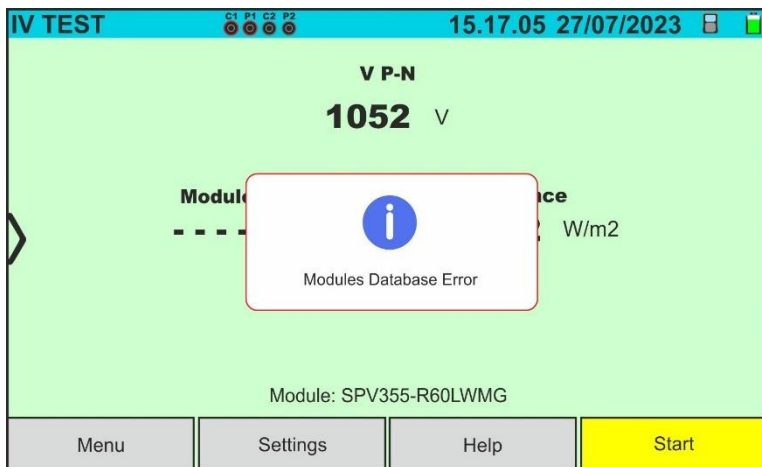

In the event of an error within the module database (e.g.: database corruption), the instrument blocks the test and the message alongside is shown on the display. Restore the default database (see § 6.3.5) to continue with the measures

6.5. IVCK – COMMISSIONING TEST ON PV MODULES AND STRINGS

6.5.1. General information

This function performs the following tests on a PV module/string by measuring only:

- **Open-circuit voltage Voc** of the PV string/module being tested, measured in **OPC** condition (**OPerative Condition**), i.e. in the real conditions in which the installation is, with or without irradiance and temperature measurement.
- **Open-circuit voltage Isc** of the PV string/module being tested, in compliance with standard IEC/EN62446, measured in **OPC** condition (**OPerative Condition**), i.e. in the real conditions in which the installation is, with or without irradiance and temperature measurement

For Voc and Isc measurements **WITHOUT irradiance and temperature measurements (and therefore without the use of the SOLAR03 remote unit)**, the instrument displays only the values evaluated under **@OPC (OPerative Conditions)** conditions, that is under the actual conditions of the plant, compares them with the **average values** (rolling average of the last 10 measurements stored) and displays the result for comparison of average values.

For Voc and Isc measurements **WITH Irradiance and Temperature** the data measured under OPC conditions are automatically "translated" by the instrument into **@STC** conditions (**Standard Test Condition** - Irradiance = 1000W/m², Module Temperature = 25 °C, Spectral Distribution AM=1.5) to make a comparison with the characteristics declared by the module manufacturer. **In these conditions it is strictly necessary to use the SOLAR03 remote unit in order to connect the irradiation and temperature probes.**

The irradiance and module temperature measurements are performed via one or more **HT305** reference cells (**in the case of Bifacial modules**) and with a **PT305** temperature probe connected to the SOLAR03 remote unit which communicates the data in real time with the instrument **via Bluetooth connection**.



CAUTION

For the irradiation measurements carried out with the **HT305** reference cell(s) **it is not necessary** to set the relative sensitivity and alpha values which are **automatically** managed by the SOLAR03 after connecting these accessories to this remote unit

In general, the result page will include:

- Description of the module used
- Irradiance and temperature values (if available)
- Average values of Voc and Isc calculated as average of the corresponding values under OPC on the last 10 tests saved in the memory. If the number of tests is < 10, the average is calculated on the number of available tests. The first test will display dashes in the field "average values" as there are no previous tests on which to calculate an average.
- The values of Voc and Isc measured under OPC as well as any partial result (only available if STC values are not available) obtained by comparison with average values.
- The values of Voc and Isc calculated under STC (if available) and any partial result obtained by comparing the values calculated under STC with the nominal ones (inserted in DB modules)
- The overall test outcome will be calculated basing on the partial outcomes in STC (if available) or basing on the partial outcomes in OPC (if STC values are not available).
- The instrument will not display any overall outcome if no partial outcome is available

6.5.2. IVCK test without remote unit SOLAR03



CAUTION

- The maximum voltage between the P1, C1, P2 and C2 inputs is 1500VDC. Do not measure voltages exceeding the limits given in this manual.
- Do not perform tests on PV modules or strings connected to the DC/AC converter.
- **The maximum current measured by the instrument is 40A**
- Standard IEC/EN62446-1 requires that measurements are performed string by string. Even if the instrument is designed to handle inrush current for single strings or strings connected in parallel, we recommend testing **one string at a time** in accordance with the standard.
- The final result is obtained by comparing the results obtained on each module/string without any correction for irradiance or temperature. **It is therefore recommended that this mode is only used in sufficiently stable environmental conditions** (clear skies, no reflected irradiance, no shading)

1. Switch on the instrument by pressing the **ON/OFF** key
2. Note the presence of the "X" in the top right corner of the display to indicate the absence of an active SOLAR03 remote unit connected to the instrument. If not, execute the "Unpair" command for the currently active unit (see § 6.2)
3. Connect the instrument to the module/string being tested as shown in Fig. 56. In particular, connect the Negative pole of the module/string to the **P2, C2** terminals and the Positive pole from the module/string to the **P1, C1** terminals

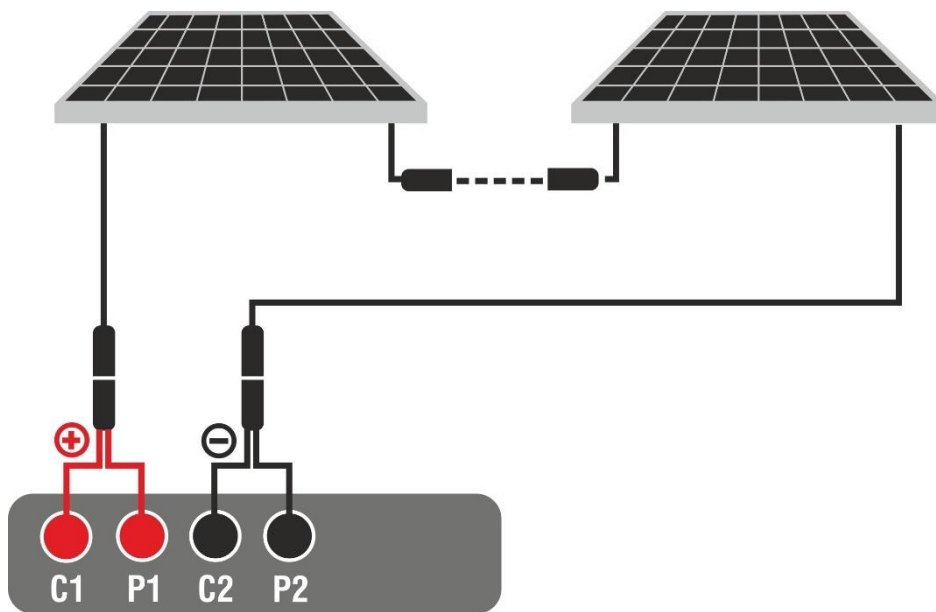

Fig. 56: Connection for IVCK tests without remote unit

7. In the case of **Monofacial** modules, the Fig. 57 screen is present on the display. The following parameters are shown:
 - VPN voltage between positive and negative pole of the string
 - Module temperature with "- - -" indication
 - Module irradiance with "- - -" indication
 - Display of currently selected PV module
 - References of **C1, P1, C2, P2** terminals connected to the instrument

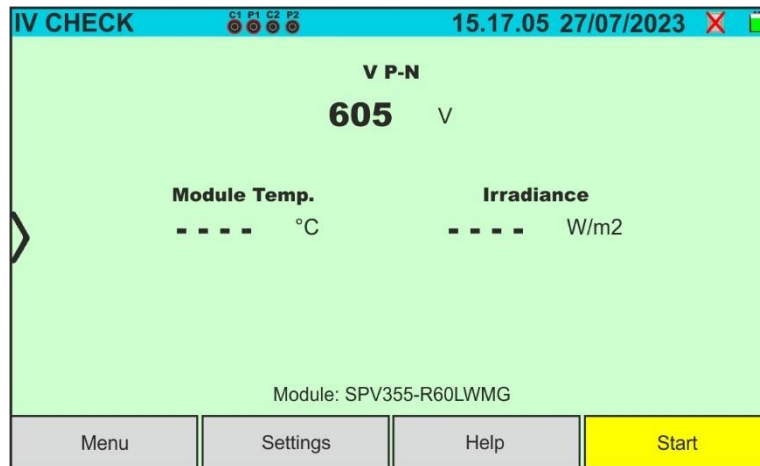

Fig. 57: Initial IVCK test screen without remote unit on Monofacial modules

8. In the case of **Bifacial** modules, the Fig. 58 screen is present on the display. The following parameters are shown:

- VPN voltage between positive and negative pole of the string
- Module temperature with "- - -" indication
- Irradiance of the front of the module with "- - -" indication
- Irradiance of the back of the module with "- - -" indication
- Display of currently selected PV module
- References of **C1, P1, C2, P2** terminals connected to the instrument



Fig. 58: Initial IVCK test screen without remote unit on Bifacial modules

9. Tap on the **"Settings"** key (Monofacial module reference). The following screen is shown in Fig. 59. The following parameters are given:



- Voc_avg and Isc_avg values of the currently selected module
- Parameters of the test string to be programmed
- Icon  to save the settings and return to the main screen, or icon  to exit without saving



Fig. 59: IVCK test parameter settings

10. Tap on the "**PV Module**" key to change the PV module to be tested. The instrument opens the DB section, where a new module can be selected from the list in the DB section (see § 6.3)
11. Drag each of the 5 available thumb wheels to the right or left in order to set the desired value of the following parameters:
 - **Num. Mod** → to set the number of modules in the string being tested (**max. 60**)
 - **N. String Paral.** → to set the number of strings in parallel (**max. 5**). Setting "1" indicates the presence of only one string
 - **Temp. Mode** → to set the module temperature measurement mode. The following options are available: **Auto** (temperature calculated by the instrument based on Voc measurement - **no probe connected and recommended option**), **Meas.** (temperature measured via PT305 probe connected to the SOLAR03 remote unit)
 - **Tol. ± Voc [%]** → setting of the percentage tolerance in the measurement of Voc in the range: **1% ÷ 20% (typical 5%)**
 - **Tol. ± Isc [%]** → setting of the percentage tolerance in the measurement of Isc in the range: **1% ÷ 20% (typical 10%)**
12. Tap on the "**Reset AVG**" key to reset the average values of the Voc_avg and Isc_avg parameters (average values of Voc and Isc in the 10 previously saved tests) before starting a new measurement. The following screen will appear:

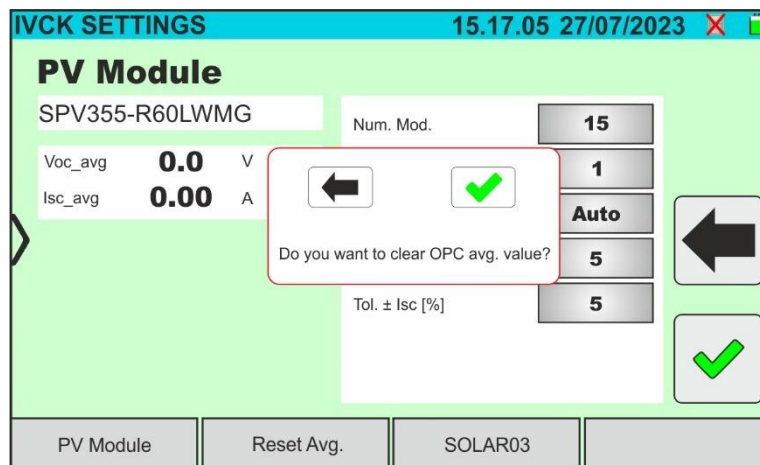

Fig. 60: Resetting average Voc and Isc values in the IVCK test

13. Tap on the key to confirm or on the key to exit without proceeding

CAUTION



When **START/STOP** (or **Start** on the display) is pressed, the instrument may give various error messages (see § 6.4.6) and, as a result, fail to perform the test. Check and, if possible, eliminate the cause of the problem before proceeding.

11. Press the **START/STOP** key (or **Start** on the display) to activate the test. If there are no error conditions, the instrument displays for a few moments the icon “⌚” together with the message "**Measuring...**". The test can take **up to approximately 20 seconds**, depending on the open circuit voltage and module parameters. At the end of the test, if the result of the test is **positive**, the following screen will appear on the display (Monofacial modules are used for ease of reference):



Fig. 61: Example of a positive IVCK test result - OPC values

12. If the result is **negative**, the following screen is shown:



Fig. 62: Example of a negative IVCK test result - OPC values

13. The following parameters are displayed on the above screens:

- Model of the module being tested
- Average values of Voc and Isc calculated as the average of the corresponding values under OPC **on the last 10 tests stored memory**. If the number of tests is < 10, the average is calculated on the number of available tests. The first test will show '- - -' in the "average values" field as there are no previous tests from which to calculate the average
- Measurement results calculated under OPC conditions
- Icons , , , to indicate the outcome of the measurement

11. Tap on to save the measurement (see § 7.1) or the icon to exit

CAUTION

- The average values of Voc and Isc are displayed on the result page. These values include the **average values of Voc and Isc under OPC conditions calculated as a rolling average of the last 10 previously stored tests**. If the user has carried out and saved a number of tests <10 or reset the average values, the average value displayed during test N+1 will be calculated on the available N values.
- When using the instrument like this, the average values previously calculated are particularly important. When starting a new measurement campaign with significant variations in irradiance or temperature, it is **recommended to reset ("Reset AVG" control)** the reference average values and then recalculate them based on new measurements. Average values are anyway zeroed in case the user changes the number of modules and/or strings.

12. For the meaning of the results see § 6.5.5

6.5.3. IVCK test with remote unit SOLAR03 in direct connection

Irradiance and temperature measurements (if the instrument is set to temperature measurement mode "Meas.") using a SOLAR03 remote unit directed connected to the device via Bluetooth are recommended when irradiance conditions are unstable or when a comparison with the nominal values of the module declared by the manufacturer is required. In this case the instrument directly provides the results of the @STC measurements.



CAUTION

- The maximum voltage between the P1, C1, P2 and C2 inputs is 1500VDC. Do not measure voltages exceeding the limits given in this manual.
- Do not perform tests on PV modules or strings connected to the DC/AC converter.
- **The maximum current measured by the instrument is 40A.**
- Standard IEC/EN62446-1 requires that measurements are performed string by string. Even if the instrument is designed to handle inrush current for single strings or strings connected in parallel, we recommend testing **one string at a time** in accordance with the standard.

1. Switch on the instrument by pressing the **ON/OFF** key
2. Switch on the SOLAR03 remote unit, pair it with and connect it to the instrument as described in § 6.2. Note the presence of the "BT" icon in the top right corner of the display
3. Connect the instrument and the SOLAR03 remote unit to the module/string being tested as shown in Fig. 63. In detail:
 - Connect the Negative pole output of the module/string to terminals **P2, C2** and the Positive pole output of the module/string to terminals **P1, C1**
 - **In case of Monofacial modules** → position the reference cell **HT305** onto the front surface of module (**F**) and at input "INP1" and **possibly** temperature probe **PT305** at input "INP4" of the remote unit.
 - **In case of Bifacial modules**→, position the **three HT305 reference cells** on the front surface of module (**F**), on the top back section (**B T=BackTop**) and on the bottom back section (**BB=BackBottom**) of the module. Connect the front reference cell (F) to input "INP1", BT reference cell to input "INP2", BB reference cell to input "INP3" and **possibly** the temperature probe **PT305** to input "INP4" of the remote unit. In accordance with the IEC/EN60904-1-2 standard, the instrument calculates the equivalent front-side Irradiance (**Irreq**) value, which corresponds to the Irradiance on the front surface only, which produces the same effects as the Irradiance measured on both sides, considering the **bifaciality factor** (φ) of the module according to the following relationship:

$$Irr_{Eq} = Irr_F + \varphi \times Irr_R$$

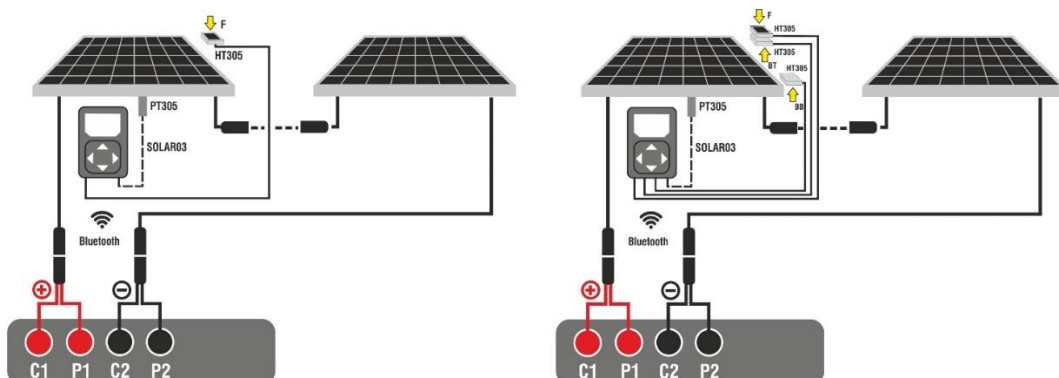

Fig. 63: Connection with remote unit SOLAR03 on Monofacial and Bifacial modules

4. In the case of **Monofacial** modules, the Fig. 64 screen is present on the display. The following parameters are shown:
- VPN voltage between positive and negative pole of the string
 - Module temperature (**with PT305 probe connected**)
 - Module irradiance measured by reference cell HT305
 - Display of currently selected PV module
 - References of **C1, P1, C2, P2** terminals connected to the instrument

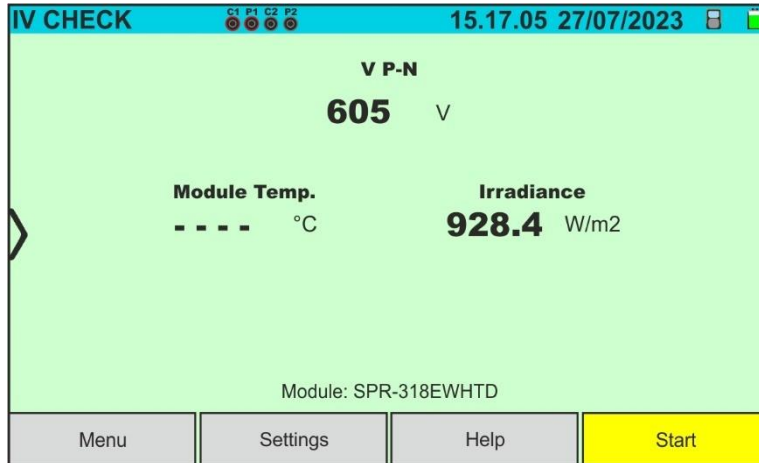

Fig. 64: Initial IVCK test screen without remote unit on Monofacial modules

5. In the case of **Bifacial** modules, the screen of Fig. 65 is present on the display. The following parameters are shown:
- VPN voltage between positive and negative pole of the string
 - Module temperature (**with PT305 probe connected**)
 - Irradiance of the front side of the module measured by reference cell HT305
 - Irradiance of the back side of the module measured by reference cells HT305

CAUTION

The "**Rear Irradiance**" parameter indicates the **minimum value** between the irradiance measured by the HT305 cells at the bottom back (BB) and top back (BT) of the module

- Display of currently selected PV module
- References of **C1, P1, C2, P2** terminals connected to the instrument

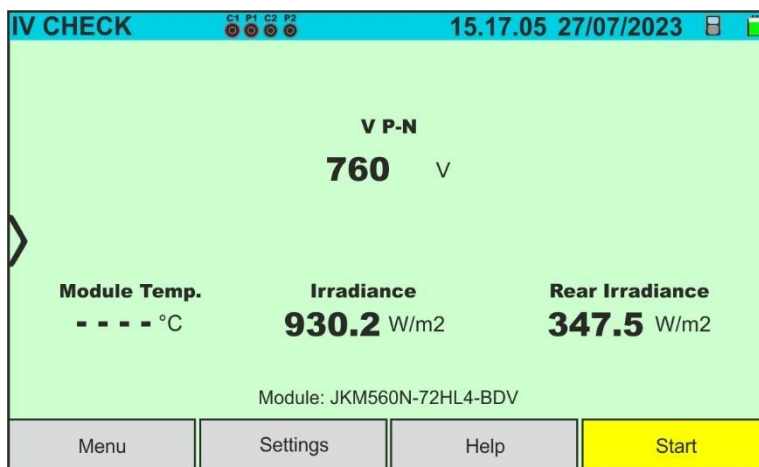



Fig. 65: Initial IVCK test screen without remote unit on Bifacial modules

6. Tap on the "**Settings**" key (Monofacial module reference). The following screen is shown in Fig. 66. The following parameters are given:

- Voc and Isc (@STC) references of the currently selected module
- Parameters of the test string to be programmed
- Icon  to save and return to the main screen, or icon  to exit without saving

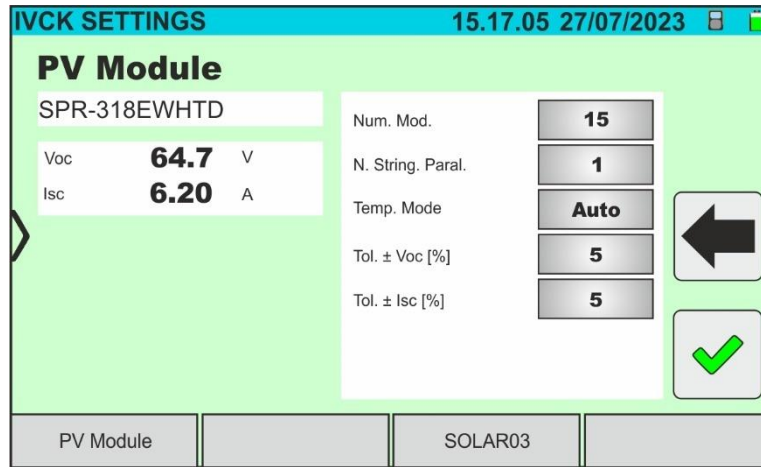
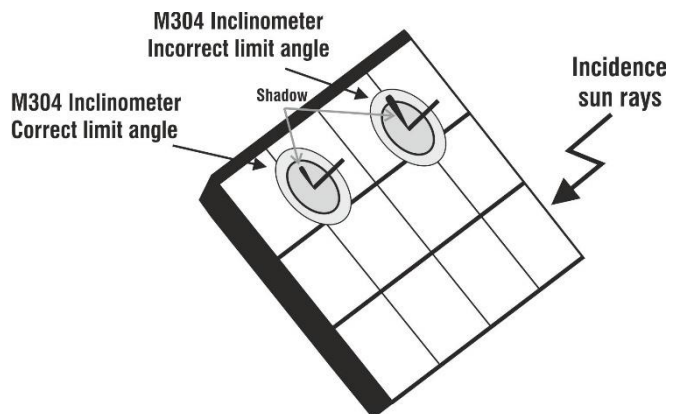

Fig. 66: I-V curve measurement parameter settings

7. Tap on the "PV Module" key to change the PV module to be tested. The instrument opens the DB section, where a new module can be selected from the list in the DB section (see § 6.3)
8. Scroll each of the 5 available thumb wheels to the right or left in order to set the desired value of the following parameters:
 - **Num. Mod.** → to set the number of modules in the string being tested (**max. 60**)
 - **N. String. Paral.** → to set the number of strings in parallel (**max. 5**). Setting "1" indicates the presence of only one overall string
 - **Temp. Mode** → to set the module temperature measurement mode. The following options are available: **Auto** (temperature calculated by the instrument based on Voc measurement - **no probe connected and recommended option**), **Meas.** (temperature measured via PT305 probe connected to the SOLAR03 remote unit)
 - **Tol. Voc ± [%]** → setting of the percentage tolerance in the measurement of Voc in the range: **1% ÷ 20% (typical 5%)**
 - **Tol. Isc ± [%]** → setting of the percentage tolerance in the measurement of Isc in the range: **1% ÷ 20% (typical 5%)**
9. Assemble the stem onto the disk of the accessory **M304** and keep it resting on the module's surface. **Check that the shadow of the stem on the disk falls within the internal "limit concentric circle" of the disk itself (see picture).** If this is not the case, the angle between the sun's rays and the module surface is too high and therefore the measurements taken by the instrument are NOT reliable. **Repeat the operations at other times of the day**



CAUTION

When **START/STOP** (or **Start** on the display) is pressed, the instrument may give various error messages (see § 6.4.6) and, as a result, fail to perform the test. Check and, if possible, eliminate the cause of the problem before proceeding.

10. Press the **START/STOP** key (or **Start** on the display) to activate the test. If there are no error conditions, the instrument will show the icon “⌚” on the display for a few moments together with the message "**Measuring...**" The test can take **up to approximately 20 seconds**, depending on the open circuit voltage and module parameters. The following screen will appear on the display in the event of a **positive test result** (for convenience, reference is made to monofacial modules)



Fig. 67: Example of a positive IVCK test result - STC values

11. If the result is **negative**, the following screen is shown:



Fig. 68: Example of a negative IVCK test result - STC values

12. The following parameters are displayed on the above screens:

- Model of the module being tested
- Nominal values of the module being tested as defined in the internal DB (see § 6.3)
- Measurement results calculated under STC conditions
- Icons , , , to indicate the outcome of the measurement

13. Tap on the icon to save the measurement (see § 7.1), or tap on the icon to exit without saving

14. For the meaning of the results see § 6.5.5

6.5.4. IVCK test with remote unit SOLAR03 in synchronous recording

The Irradiation and temperature measurements (if the instrument is set in the “Meas” temperature measurement mode) **by using the SOLAR03 remote unit connected in synchronous recording to the instrument** are **recommended** if unstable irradiation conditions are present, **in the presence of obstacles that could interrupt the connection Bluetooth**, and there is a need for comparison with the nominal values of the module declared by the manufacturer.

In this way, the active SOLAR03 remote unit must be connected via Bluetooth only at the BEGINNING and to the ENDING of the operations and NOT DURING the real irradiation and temperature measurements.

The instrument provides the results of measurements @OPC condition without outcome then performs the automatic and simultaneous @STC condition translation **only after the data transfer from the remote unit at the end of the recording and the subsequent reconnection.**



CAUTION

- The maximum voltage between inputs P, N, E and C is 1500VDC. Do not measure voltages exceeding the limits given in this manual.
- Do not perform tests on PV modules/strings connected to the DC/AC converter
- **The maximum current measured by the instrument is 40A**
- Standard IEC/EN62446 requires that measurements are performed **string by string**. Even if the instrument is designed to manage inrush current for single strings or strings connected in parallel, it is **recommend** testing **one string at a time** according to the standard’s prescriptions.

1. Switch on the instrument by pressing the **ON/OFF** key
2. Connect the instrument to the module/string being tested as shown in Fig. 69 (Monofacial modules) or Fig. 70 (Bifacial modules). In detail, connect the negative pole output of the module/string to terminals **P2, C2** and the positive pole output of the module/string to terminals **P1, C1**

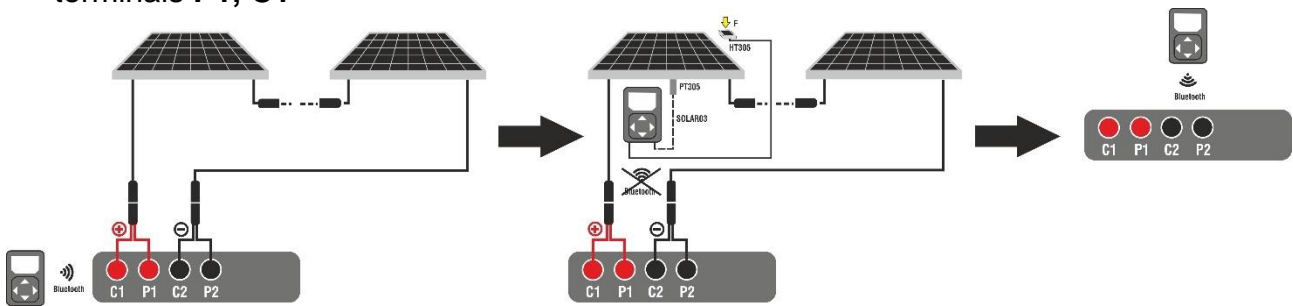

Fig. 69: Connection with SOLAR03 in synchronous recording on Monofacial modules

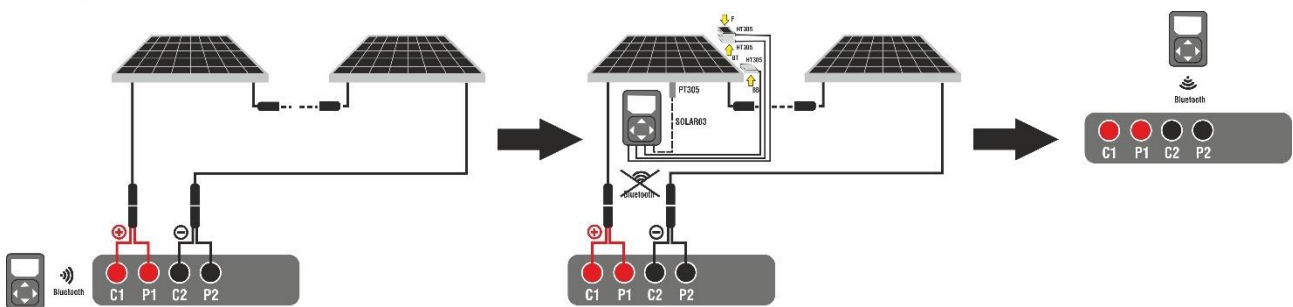

Fig. 70: Connection with SOLAR03 in synchronous recording on Bifacial modules

Step 1

3. Move the SOLAR03 remote unit close to the instrument as shown in Fig. 69 or Fig. 70 – left side part
4. Turn on the SOLAR03 remote unit, pair it and connect it to the instrument as indicated in § 6.2. Note the presence of the "☎" icon at the top right of the display
5. To start recording on the connected remote unit, tap on the "Start/Stop" key. The following screen will appear:



Fig. 71: Recording Activation on Remote Unit - Step 1

6. Tap on to confirm or tap on to exit without proceeding. The recording is performed **with a non-modifiable 1s scan** and the message "REC" appears on the display of the remote unit to indicate the operation in progress:

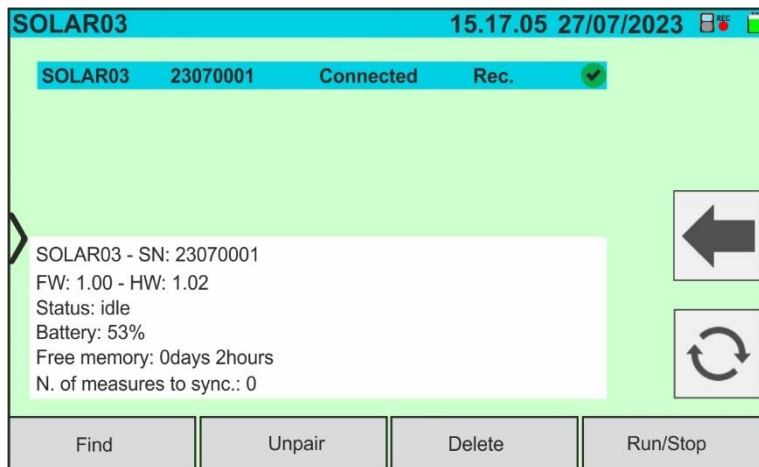

Fig. 72: Recording Activation on Remote Unit - Step 2

7. The  icon and the message "Rec" appear on the display

Step 2

8. **Move the remote unit close to the modules** and connect the irradiance and temperature probes (if necessary) as shown in Fig. 69 or Fig. 70 – middle side part. In particular:

- **In case of Monofacial modules** → position the reference cell **HT305** onto the front surface of module (**F**) and at input “**INP1**” and **possibly** temperature probe **PT305** at input “**INP4**” of the remote unit
- **In case of Bifacial modules**→, position the **three HT305 reference cells** on the front surface of module (**F**), on the top back section(**BT=BackTop**) and on the bottom back section (**BB=BackBottom**) of the module. Connect the front reference cell (F) to input “**INP1**”, BT reference cell to input “**INP2**”, BB reference cell to input “**INP3**” and **possibly** the temperature probe **PT305** to input “**INP4**” of the remote unit. In accordance with the IEC/EN60904-1-2 standard, the instrument calculates the equivalent front-side Irradiance (**Irreq**) value, which corresponds to the Irradiance on the front surface only, which produces the same effects as the Irradiance measured on both sides, considering the **bifaciality factor** (φ) of the module according to the following relationship:

$$Irr_{Eq} = Irr_F + \varphi \times Irr_R$$

9. **Since recording has already been activated on remote unit SOLAR03, it is not necessary to maintain the Bluetooth connection anymore.** Maintaining the connection will only allow to immediately obtain the outcome of the test without waiting for the measuring campaign to be completed.

10. In the case of **Monofacial** modules, the Fig. 73 screen is shown on the display. The following parameters are indicated:

- VPN voltage between positive and negative pole of the string
- Module temperature with “- -” indication as the remote unit is not connected
- Module irradiance with “- -” indication as the remote unit is not connected
- Display of currently selected PV module
- References of **C1, P1, C2, P2** terminals connected to the instrument



Fig. 73: IVCK test screen with SOLAR03 in synchronous recording on Monofacial modules

10. In the case of **Bifacial** modules, the Fig. 74 screen is shown on the display. The following parameters are indicated:

- VPN voltage between positive and negative pole of the string
- Module temperature with "- - -" indication
- Irradiance of the front of the module with "- - -" indication
- Irradiance of the back of the module with "- - -" indication
- Display of currently selected PV module
- References of **C1, P1, C2, P2** terminals connected to the instrument

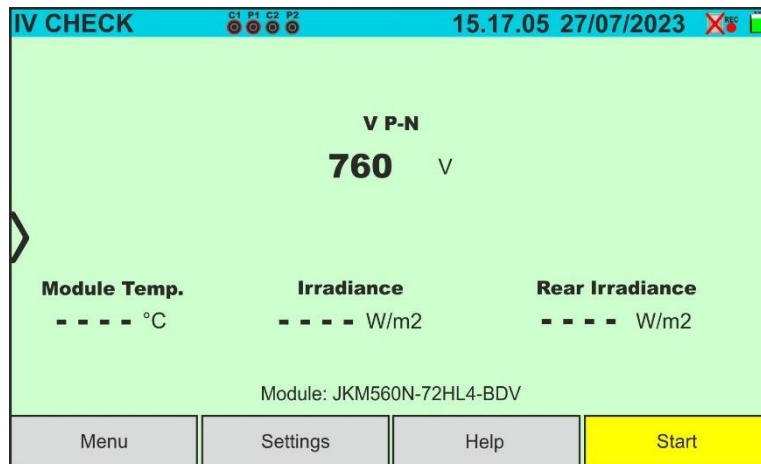

Fig. 74: IVCK test screen with SOLAR03 in synchronous recording on Bifacial modules

11. Tap on the "**Settings**" key (Monofacial module reference). The following screen is shown in Fig. 59. The following parameters are given:

- Voc and Isc (@STC) references of the currently selected module
- Parameters of the test string to be programmed
- Icon to save the settings and return to the main screen, or icon to exit without saving

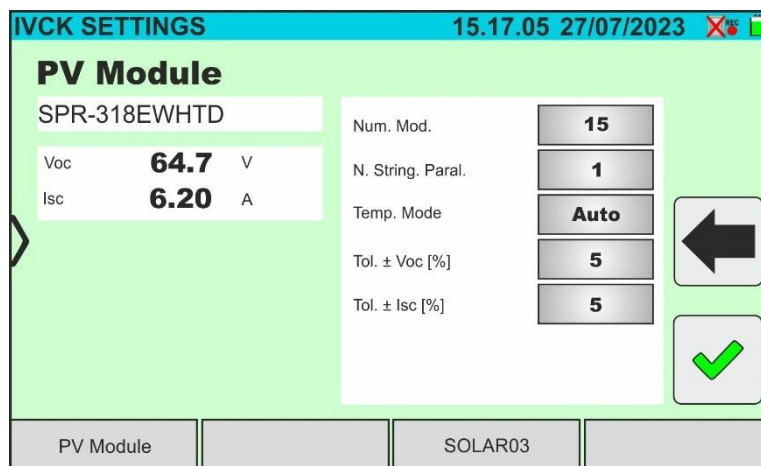

Fig. 75: IVCK test parameter settings with SOLAR03 in synchronous recording

12. Tap on the "**PV Module**" key to change the PV module to be tested. The instrument opens the DB section, where a new module can be selected from the list in the DB section (see § 6.3)

13. Drag each of the 5 available thumb wheels to the right or left in order to set the desired value of the following parameters:

- **Num. Mod** → to set the number of modules in the string being tested (**max. 60**)
- **N. String Paral.** → to set the number of strings in parallel (**max. 5**). Setting "1" indicates the presence of only one string
- **Temp. Mode** → to set the module temperature measurement mode. The following options are available: **Auto** (temperature calculated by the instrument based on Voc measurement - **no probe connected and recommended option**), **Meas.** (temperature measured via PT305 probe connected to the SOLAR03 remote unit)
- **Tol. ± Voc [%]** → setting of the percentage tolerance in the measurement of Voc in the range: **1% ÷ 20% (typical 5%)**
- **Tol. ± Isc [%]** → setting of the percentage tolerance in the measurement of Isc in the range: **1% ÷ 20% (typical 10%)**

15. Assemble the stem onto the disk of the accessory **M304** and keep it resting on the module's surface. **Check that the shadow of the stem on the disk falls within the internal "limit concentric circle" of the disk itself (see picture).** If this is not the case, the angle between the sun's rays and the module surface is too high and therefore the measurements taken by the instrument are NOT reliable. **Repeat the operations at other times of the day**

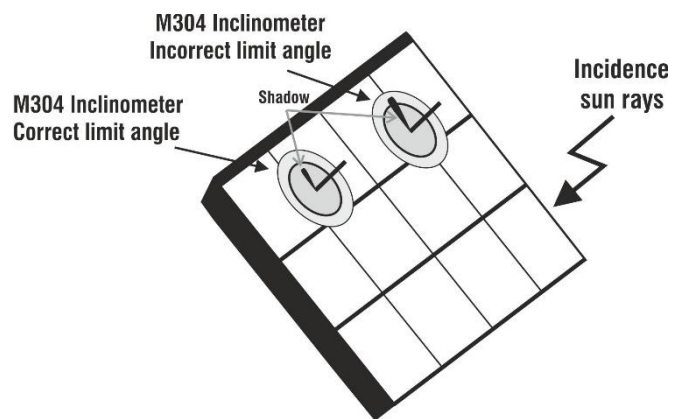

CAUTION





- When **START/STOP** (or **Start** on the display) is pressed, the instrument may give various error messages (see § 6.4.6) and, as a result, fail to perform the test. Check and, if possible, eliminate the cause of the problem before proceeding
- The settings made on the instrument control parameters can be modified at any time even while recording is in progress

16. Press the **START/STOP** key (or **Start** on the display) to activate the tests. If there are no error conditions, the instrument will show the icon "⌚" on the display for a few moments together with the message "**Measuring...**" The test can take **up to approximately 20 seconds**, depending on the open circuit voltage and module parameters. At the end of the test, the instrument will **only** display the values **measured at OPC without the references of the irradiance and temperature values of the module** (see Fig. 76) and it is necessary to wait for the end of the test session and the **subsequent synchronisation** with the SOLAR03 remote unit to obtain the final result (values @ STC) of the tests performed, as shown here below:



Fig. 76: IVCK test result @OPC with synchronous recording

17. Tap on the  icon to save the measurements to the internal memory (see § 7.1), or on the  icon to exit without saving

Step 3

18. **At the end of the test session**, disconnect the SOLAR03 remote unit, place it close to the instrument (see Fig. 69 or Fig. 70 – right side part) and check that it automatically reconnects to the instrument
19. Tap on the "SOLAR03" button to access the control and management section of the SOLAR03 remote unit (see § 6.2) connected to the instrument
20. Tap on the "Start/Stop" key to **end** the recording. The following screen will appear:

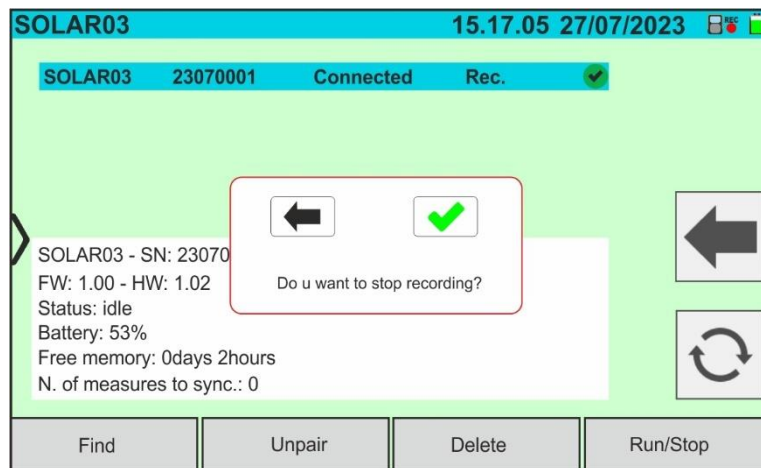





Fig. 77: Ending recording on the remote unit

21. Tap on the  key to confirm or on the  key to exit without proceeding
22. The synchronization of the pending @OPC measurements, the translation of the @STC values and the subsequent saving are performed **automatically** by the instrument. The "N. of measures to sync" parameter must take on the value "0" once the operations are completed
23. Tap on the  icon if there are some errors, to reactivate synchronization again
24. Access the memory area (see § 7.2) to retrieve the saved measurements

CAUTION

The instrument translates @OPC results to @STC values when the following conditions occur:



19. Voltage $V_{oc} > V_{oc \text{ minimum}} = 15V$
20. **Frontal** irradiance values (also valid for bifacial modules) detected as greater than the minimum threshold set on the instrument ($>100W/m^2$) and **stable** (variation between the start and end of the measurement campaign $\pm 20 W/m^2$)
21. Open voltage V_{oc} measured consistent with expected value indicated in the module datasheet
22. Module temperature value included in the range: $-40^{\circ}C \div 100^{\circ}C$ ($-40^{\circ}F \div 212^{\circ}F$)
23. Short-circuit current value $I_{sc} > I_{sc \text{ min}} = 0.2A$

24. For the meaning of the results see § 6.5.5

6.5.5. Interpretation of measurement results

In general, the result of a test on a Voc and Isc measurement is determined by the following relationships:

Measurements without remote unit (no irradiation and temperature)

Note the following parameters:

- VocAve → average open voltage value calculated in the last 10 saved measurements
- IscAve → average short circuit current value calculated in the last 10 saved measurements
- Voc (Tol+) = $Tol\%(+)Voc * VocAve$ → Positive tolerance value on Voc
- Voc (Tol-) = $Tol\%(-)Voc * VocAve$ → Negative tolerance value on Voc
- Isc (Tol+) = $Tol\%(+)Isc * IscAve$ → Positive tolerance value on Isc
- Isc (Tol-) = $Tol\%(-)Isc * IscAve$ → Negative tolerance value on Isc

$\epsilon_{InstrumVoc}$ → Maximum instrumental error declared on the Voc @OPC (see § 10.1)

$\epsilon_{InstrumIsc}$ → Maximum instrumental error declared on the Isc @OPC (see § 10.1)

The following check parameters are calculated by the instrument:

$\epsilon_{MeasVoc} = Voc (@OPC) - VocAve$ → Error on the measurement of Voc @ OPC

$\epsilon_{MeasIsc} = Isc (@OPC) - IscAve$ → Error on the measurement of Isc @ OPC

The following conditions on the measurement outcome are managed by the instrument

N	CONDITION	OUTCOME
1	<ul style="list-style-type: none"> ➤ - $Voc (Tol-) + \epsilon_{InstrumVoc} \leq \epsilon_{MeasVoc} \leq Voc (Tol+) - \epsilon_{InstrumVoc}$ ➤ - $Isc (Tol-) + \epsilon_{InstrumIsc} \leq \epsilon_{MeasIsc} \leq Isc (Tol+) - \epsilon_{InstrumIsc}$ 	
2	<ul style="list-style-type: none"> ➤ - $Voc (Tol-) \leq \epsilon_{MeasVoc} \leq Voc (Tol+)$ ➤ - $Isc (Tol-) \leq \epsilon_{MeasIsc} \leq Isc (Tol+)$ 	
3	<ul style="list-style-type: none"> ➤ - $Voc (Tol-) - \epsilon_{InstrumVoc} \leq \epsilon_{MeasVoc} \leq Voc (Tol+) + \epsilon_{InstrumVoc}$ ➤ - $Isc (Tol-) - \epsilon_{InstrumIsc} \leq \epsilon_{MeasIsc} \leq Isc (Tol+) + \epsilon_{InstrumIsc}$ 	
4	➤ The previous conditions 1, 2 and 3 are not verified	

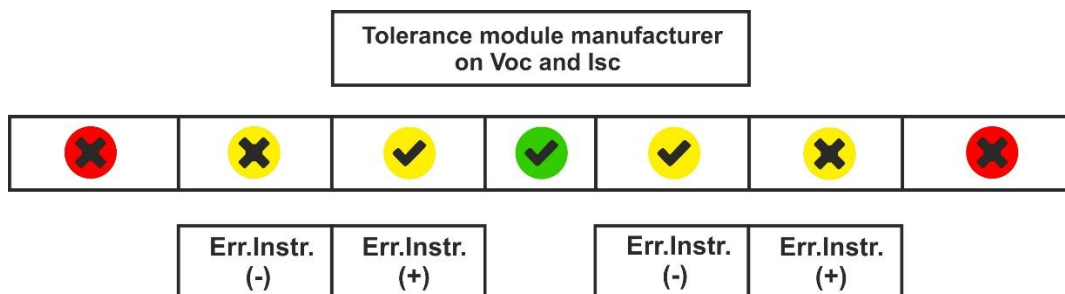

Measurements with remote unit (irradiation and temperature)

Note the following parameters:

- VocNom → nominal open voltage value of Voc (declared by the manufacturer)
- IscNom → nominal short circuit current value of Isc (declared by the manufacturer)
- Voc (Tol+) = **Tol%(+)Voc * VocNom** → Positive tolerance value on Voc
- Voc (Tol-) = **Tol%(-)Voc * VocNom** → Negative tolerance value on Voc
- Isc (Tol+) = **Tol%(+)Isc * IscNom** → Positive tolerance value on Isc
- Isc (Tol-) = **Tol%(-)Isc * IscNom** → Negative tolerance value on Isc

$\epsilon_{InstrumVoc}$ → Maximum instrumental error declared on the Voc @STC (see § 10.1)

$\epsilon_{InstrumIsc}$ → Maximum instrumental error declared on the Isc @STC (see § 10.1)

The following check parameters are calculated by the instrument:

$\epsilon_{MeasVoc}$ = Voc (@STC) – VocNom → Error on the measurement of Voc @ STC

$\epsilon_{MeasIsc}$ = Isc (@STC) – IscNom → Error on the measurement of Isc @ STC

NOTE: Voc (@STC) and Isc (@OPC) values are obtained in accordance with **IEC/EN60891**

The following conditions on the measurement outcome are managed by the instrument:

N	CONDITION	OUTCOME
1	<ul style="list-style-type: none"> ➤ - Voc (Tol-) + $\epsilon_{InstrumVoc} \leq \epsilon_{MeasVoc} \leq$ Voc (Tol+) - $\epsilon_{InstrumVoc}$ ➤ - Isc (Tol-) + $\epsilon_{InstrumIsc} \leq \epsilon_{MeasIsc} \leq$ Isc (Tol+) - $\epsilon_{InstrumIsc}$ 	
2	<ul style="list-style-type: none"> ➤ - Voc (Tol-) $\leq \epsilon_{MeasVoc} \leq$ Voc (Tol+) ➤ - Isc (Tol-) $\leq \epsilon_{MeasIsc} \leq$ Isc (Tol+) 	
3	<ul style="list-style-type: none"> ➤ - Voc (Tol-) - $\epsilon_{InstrumVoc} \leq \epsilon_{MeasVoc} \leq$ Voc (Tol+) + $\epsilon_{InstrumVoc}$ ➤ - Isc (Tol-) - $\epsilon_{InstrumIsc} \leq \epsilon_{MeasIsc} \leq$ Isc (Tol+) + $\epsilon_{InstrumIsc}$ 	
4	➤ The previous conditions 1, 2 and 3 are not verified	

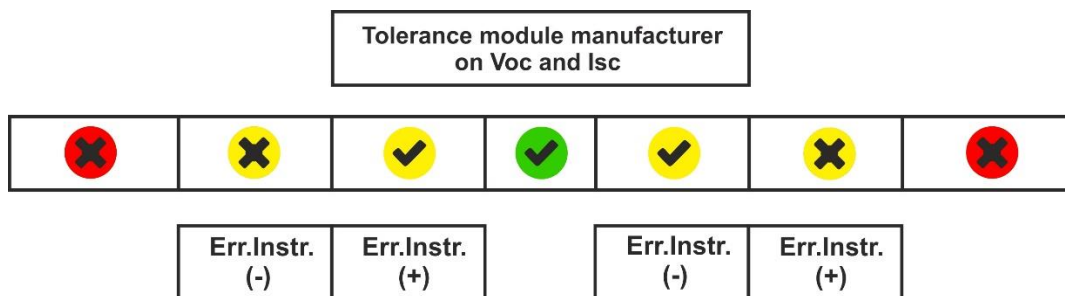

Application example (measurement with remote unit)

- Module name: **LR5-54HIH-410M (LONGI manufacturer)**
- Module type: Mono-facial
- Declared nominal Voc voltage (@STC): 37.3V
- Declared nominal short circuit current Isc (@ STC): 13.88A
- Tolerance Voc: ±5%
- Tolerance Isc: ±10%
- Frontal irradiance measured: 577 W/m²
- Module temperature (@STC): 25°C
- Voltage Voc calculated by the instrument (@STC): 37.1V
- Short circuit current Isc calculated by the instrument (@STC): 10.53A

$$Voc (Tol+) = Tol\%(+)Voc * VocNom = 0.05 * 37.3V = 1.9V$$

$$Voc (Tol-) = Tol\%(-)Voc * VocNom = 0.05 * 37.3V = 1.9V$$

$$Isc (Tol+) = Tol\%(+)Isc * IscNom \rightarrow = 0.1 * 13.88 = 1.39A$$

$$Isc (Tol-) = Tol\%(-)Isc * IscNom \rightarrow = 0.1 * 13.88 = 1.39A$$

$$\epsilon_{Instrum}Voc = \pm(37.1 * 0.04 + 0.2) = \pm 1.7V$$

$$\epsilon_{Instrum}Isc = \pm(10.53 * 0.04 + 0.02) = \pm 0.44A$$

$$\epsilon_{Meas}Voc = Voc (@STC) - VocNom = 37.1 - 37.3 = - 0.2V$$

$$\epsilon_{Meas}Isc = Isc (@STC) - IscNom = 10.53 - 13.88 = - 3.35A$$

Comparison conditions:

Voc Voltage $\rightarrow -1.9 + 1.7 \leq -0.2 \leq 1.9 - 1.7 \rightarrow$ Verified condition 1 \rightarrow **Outcome** 

Isc Current $\rightarrow -1.39 + 0.44 \leq -3.35 \leq 1.39 - 0.44 \rightarrow$ Condition 1 NOT verified

Isc Current $\rightarrow -1.39 \leq -3.35 \leq 1.39 \rightarrow$ Condition 2 NOT verified

Isc Current $\rightarrow -1.39 - 0.44 \leq -3.35 \leq 1.39 + 0.44 \rightarrow$ Condition 3 NOT verified

Isc Current \rightarrow Verified condition 4 \rightarrow **Outcome** 

7. MEM - STORAGE OF RESULTS

The instrument can store up to **up to 9999** measurement results (I-V curves or IVCK tests). Test results can be organised and grouped in a structure similar to that of the photovoltaic system being tested by associating **up to 3** different **levels of** markers for each of the memory locations used, in order to detail the corresponding location of the measurement. For example, a location tested as 'Plant XX', 'String YY', 'Module ZZ' can be stored and associated with the measurement just taken.

7.1. SAVING MEASURES

1. With the measurement on the display, tap on the  icon to save. **When saving for the first time (empty memory), a first-level marker must be defined** and the following screen will be displayed



Fig. 78: Saving Measurement Result - Step 1

2. Tap on the  key to confirm. The following screen will be displayed:



Fig. 79: Saving Measurement Result - Step 2

3. The instrument shows a list of possible pre-defined markers. Use the virtual alphanumeric keyboard to define a new marker string (ex: "PLANT A") and touch the  (ENTER) button to confirm. The name will appear in the list of markers highlighted **in blue**, as shown in the following figure.



Fig. 80: Saving Measurement Result - Step 3

4. With a first-level marker highlighted, tap on the **"New"** key to define a possible name for a **second-level** marker. The following screen will appear:



Fig. 81: Saving Measurement Result - Step 4

5. Use the virtual alphanumeric keyboard to define the **second-level** marker (ex: "STRING 1") and touch the  (ENTER) button to confirm. The name will appear in the list of markers highlighted **in blue**, as shown in the following figure:

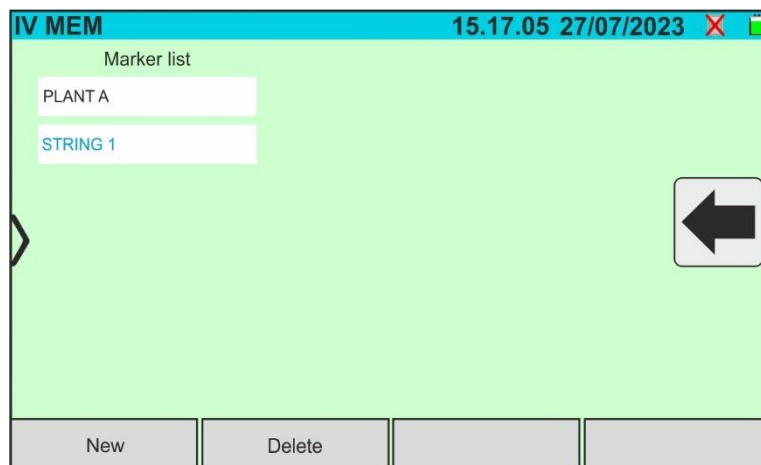

Fig. 82: Saving Measurement Result - Step 5

- With the second-level marker highlighted, tap on the “New” key to define a possible name for a **third-level** marker. The following screen will be displayed:



Fig. 83: Saving Measurement Result - Step 6



- Use the virtual alphanumeric keyboard to define the **third-level** marker (ex: "MODULE X") and touch the  (ENTER) button to confirm. The name will appear in the list of markers highlighted in **blue**, as shown in the following figure:



Fig. 84: Saving Measurement Result - Step 7

- Tap on the icon  to exit the section. The following screen appears on the display

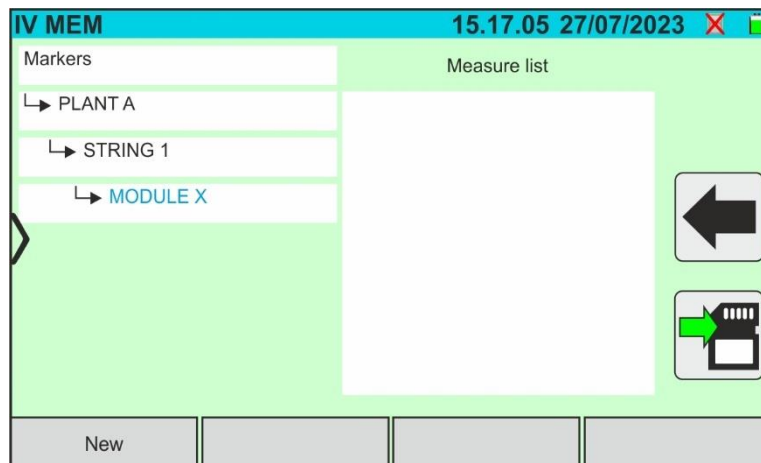



Fig. 85: Saving the measurement result - End

9. Tap on the  icon again to **complete the saving process** of the measurement under the blue highlighted marker (ex: third-level "MODULE X") and return to the main measurement screen
10. When a new first-level marker is required, tap on the "**New first level**" key shown on the following screen:

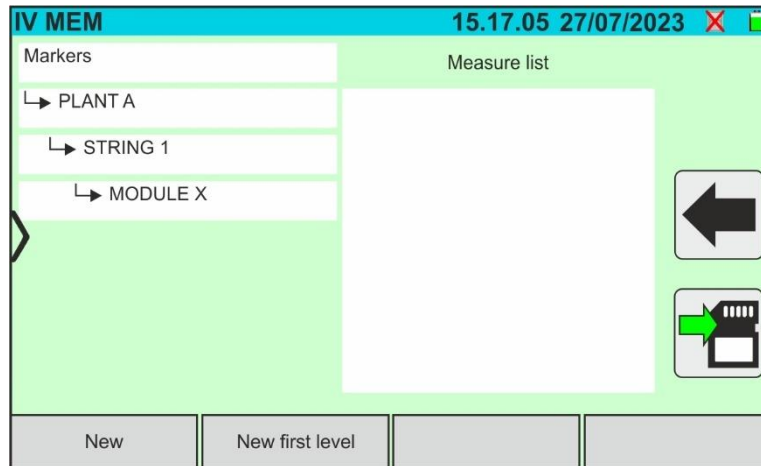

Fig. 86: Definition of new first-level marker

11. Use the virtual keyboard as described in the previous paragraphs

7.2. DISPLAYING RESULTS

1. Tap on the "Memory" icon in the main menu to display the data. The following screen shows an example of displayed data



Fig. 87: Displaying results

2. Tap on the desired marker on the left-hand side of the screen. On the right-hand side, the current memory location is shown, along with the measurements stored for that marker.
3. The following indications are possible:
 - → I-V curve measurement or IVCK test result: **correct** (Result: OK)
 - → I-V curve measurement or IVCK test result: **incorrect** (Result: NOT OK)
 - → I-V curve measurement or IVCK test result: **correct except in case of instrument error**
 - → I-V measurement or IVCK test result: **incorrect except in case of instrument error**
 - → I-V or IVCK curve measurement result **without @STC** values (only @OPC values)
4. Select a measurement by highlighting it in blue and tap on the "View Results" key to display it. In the case of Fig. 87, the following screen is displayed relative to the I-V curve measurement:



Fig. 88: Retrieving the I-V curve measurement results - Values @STC

5. Tap on the "Current" key to display the I-V @STC curve. The following screen will appear:

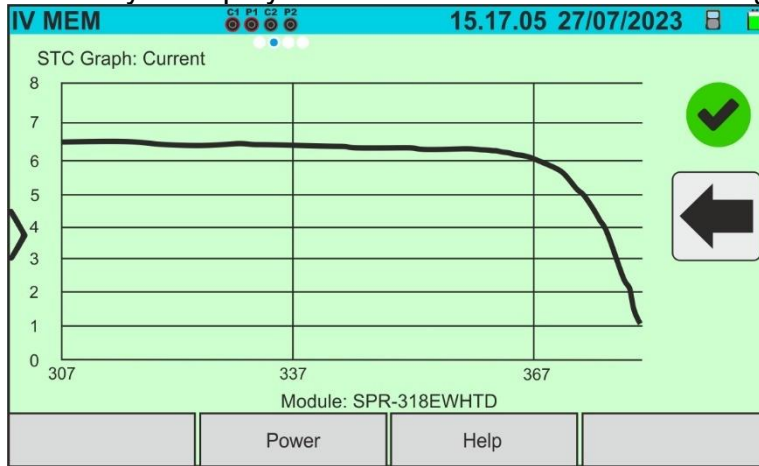

Fig. 89: Retrieving the I-V curve measurement results - Current curve @STC

6. Tap on the "Power" key to display the I-V @STC power curve as shown in the figure below:

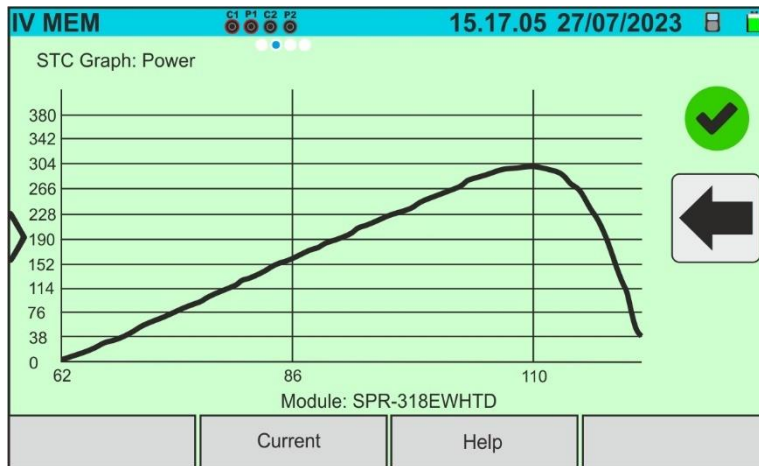

Fig. 90: Retrieving the I-V curve measurement results - Power curve @STC

7. Scroll the screen to the right to display the @OPC values. The following screen will appear:



Fig. 91: Retrieving the I-V curve measurement results - Values @OTC

8. Tap on the "Current" key to display the I-V @OPC curve. The following screen will appear:

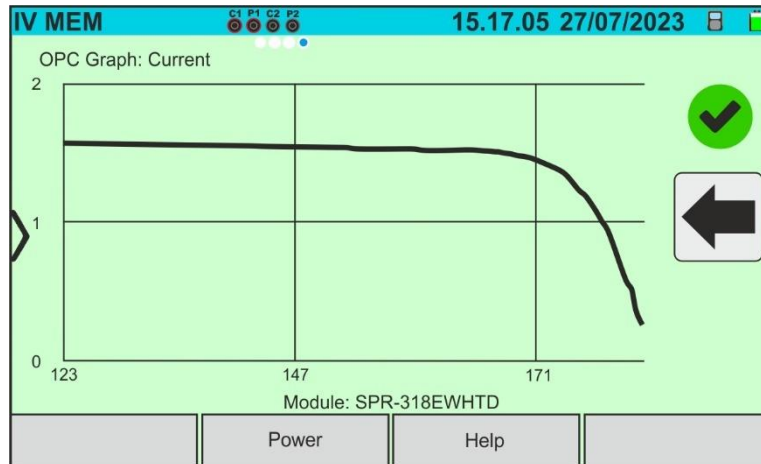

Fig. 92: Retrieving the I-V curve measurement results - Current curve @OPC

9. Tap on the "Power" key to display the @OPC power curve. The following screen will appear:

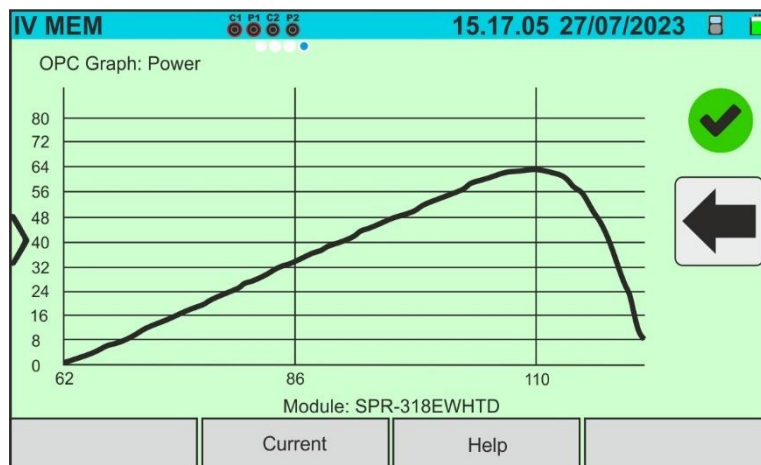

Fig. 93: Retrieving the I-V curve measurement results - Power curve @OPC

10. Tap on the "←" icon to return to the main screen

11. When retrieving the IVCK test results, the following screen will appear:



Fig. 94: Retrieving the IVCK test results @STC

7.3. DELETING RESULTS

1. Tap on the **"Memory"** icon on the main menu to display the data (see Fig. 87)
2. Select (highlight in blue) a test on the screen and tap on the **"Delete"** key. The following message will appear on the display:

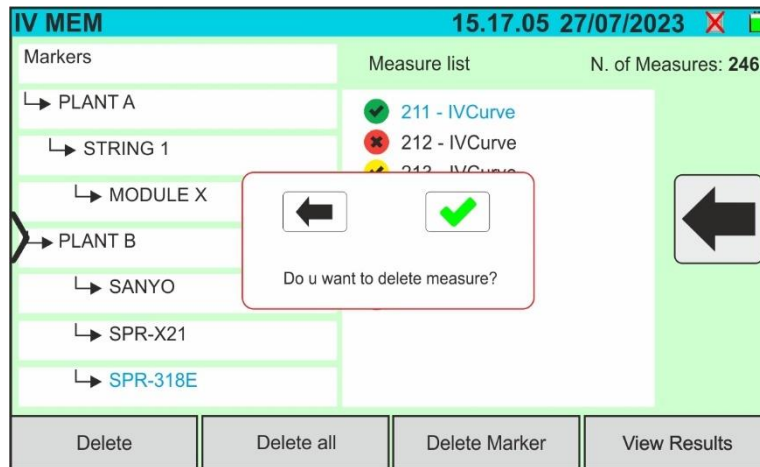

Fig. 95: Deleting a measurement result

3. Tap on the key to confirm the deletion of the measurement or on the key to exit without proceeding
4. Tap on the **"Delete all"** key to delete all measurements stored in memory. The following message will appear on the display:

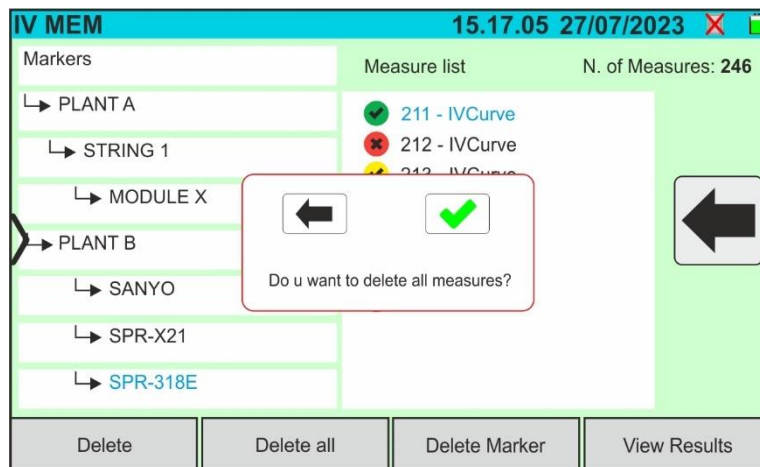

Fig. 96: Deleting an entire internal memory

5. Tap on the key to confirm the deletion of the entire internal memory or on the key to exit without proceeding
6. Select (highlight in blue) a marker on the screen and tap on the **"Delete Marker"** key. The following message will appear on the display

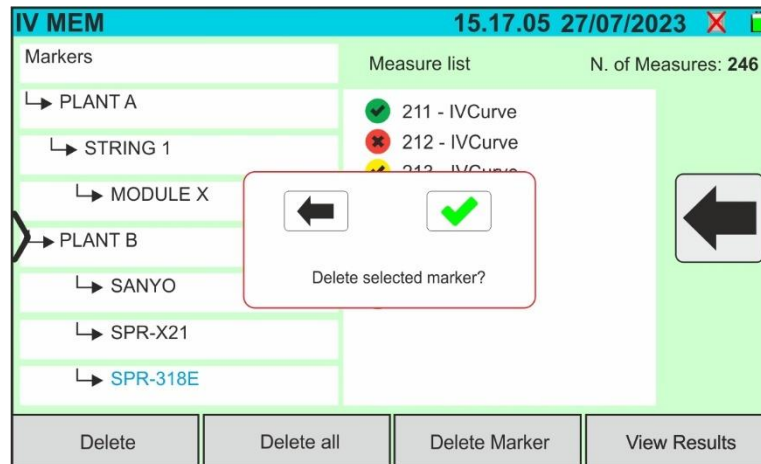
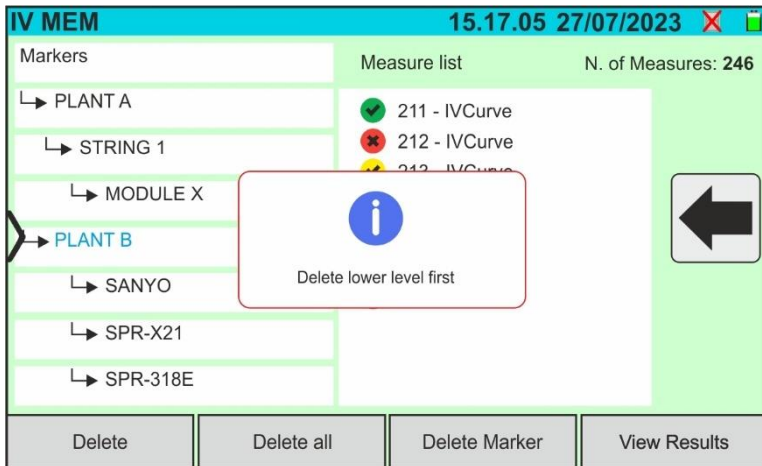

Fig. 97: Deleting an internal marker

7. Tap on the  key to confirm the deletion of the marker **together with any measurements it contains**, or on the  key to exit without proceeding

7.3.1. Anomalous situations



If a highlighted top-level marker containing some measurements is to be removed, the instrument will not proceed and will display the message shown in the figure. Remove **all lower-level markers** first

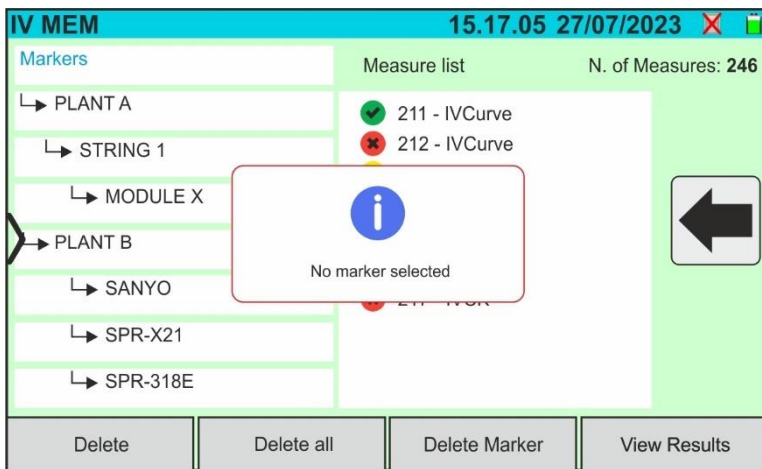

If an attempt is made to delete a marker with the word "**Markers**" highlighted, the instrument will display the message shown in the figure and will not perform the operation. **Select a valid marker**

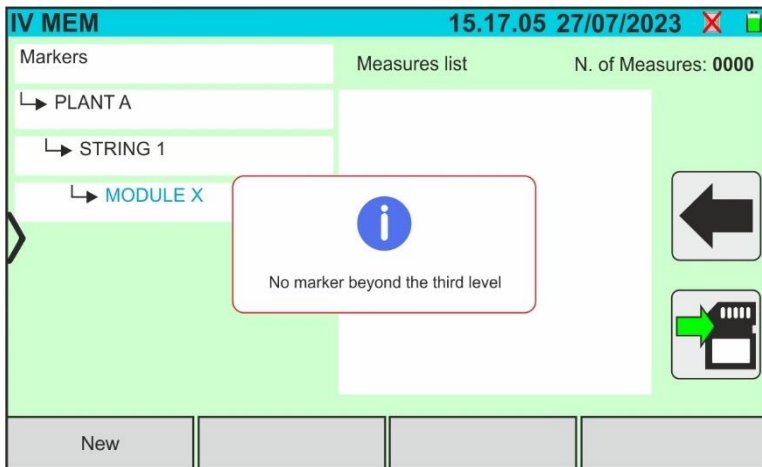

When the third-level marker is selected, touching the "**New**" key will display the screens shown in the figure and the instrument will not perform the operation. **It is not possible to define markers beyond the third level**

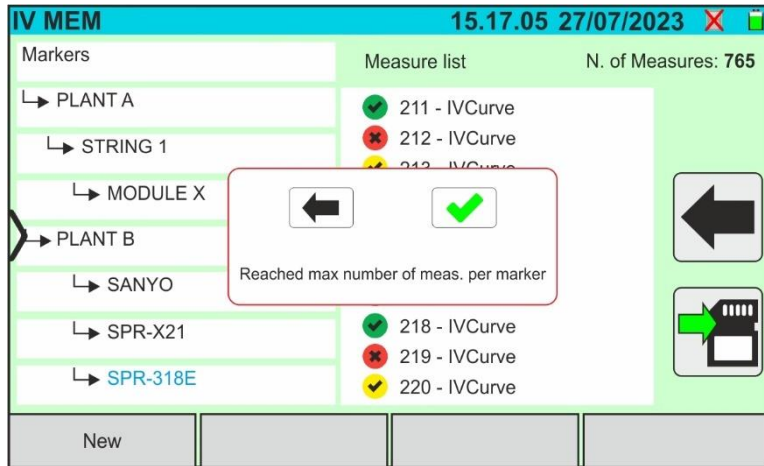

If, during saving, you try to associate a measurement with a marker in which the maximum number of possible measurements are present (**max 500**), the instrument shows the message shown in the figure on the side and does not carry out the operation. Download the measurements to the PC and delete them before saving again

8. CONNECTING THE INSTRUMENT TO THE PC

The PC is connected to the instrument via the USB-C port (see Fig. 2) using the C2010 cable supplied, or via a WiFi connection. The choice of connection type must be made within the management software HTAgorà



CAUTION

To transfer data to a PC, first install the management software HTAgorà downloadable from the www.ht-instruments.com website

Connection via USB-C cable



1. Switch on the instrument by pressing the **ON/OFF** key
2. Connect the instrument to the PC using the supplied USB-C **C2010** cable
3. Use the management software HTAgorà controls to activate the transfer

Connecting by WiFi

1. Switch on the instrument by pressing the **ON/OFF** key
2. Tap on the "**Settings**" icon on the main menu and drag the thumb wheel corresponding to the "**WiFi**" function to "**ON**" as shown in the following screen



Fig. 98: WiFi connection activation

3. Tap on the  icon to save the setting. The icon "" is shown in the top right corner of the display
4. Enable the WiFi connection on the PC (if necessary, it is possible to use a WiFi adaptor). Select and connect the WiFi network which the instrument makes available in "Network connection → Wireless networks" section on the PC
5. Use the management software HTAgorà controls to activate the transfer

9. MAINTENANCE

9.1. GENERAL INFORMATION

During use and storage, the recommendations in this manual must be followed to avoid possible damage or danger to the operator. Do not use the instrument in environments characterized by humidity or temperatures outside the environmental conditions indicated in § 10.3. Do not expose to direct sunlight. Always switch off the instrument after using it. **If the instrument is to be left unused for a long period of time, remove the batteries to prevent leaking and damage to the internal circuits of the instrument.**

9.2. REPLACING OR RECHARGING INTERNAL BATTERIES

When the low battery symbol "" appears on the display, replace (if using alkaline batteries) or recharge (if using NiMH rechargeable batteries).



CAUTION



- This operation must be carried out by skilled technicians only. Before carrying out this operation, make sure that all the cables have been removed from the input terminals
- **Only use the supplied HT power supply unit** to recharge the batteries in order to avoid possible damage to the instrument

Replacing internal batteries

1. Switch off the instrument
2. Remove the cables from the input terminals
3. Unscrew the screw securing the battery cover (see Fig. 1 - part 6) and remove it
4. Remove all the alkaline batteries and replace them with others of the same type (see § 10.2) making sure the polarity is correct (see Fig. 3)
5. Put back the battery compartment cover and fasten it by means of the appropriate screw
6. Do not dispose of the used batteries in the environment. For disposal, use appropriate containers

Recharging internal batteries

The complete recharging of the batteries **must always be carried out using the external power supply supplied**. The external power supply recharges the batteries with the instrument **both ON and OFF**. **Do not recharge alkaline batteries**. Proceed as follows:

1. Remove the cables from the input terminals
2. Move the sliding cover on the inputs to the right (see Fig. 1 - part 9) so that the "Ext P.Supply" input can be used
3. Switch on the instrument
4. Plug the external power supply unit into the instrument and connect it to the mains. The symbol "" in the top right corner of the display indicates that the internal batteries are being charged
5. Continue recharging until the icon "" appears when removing the external power supply unit

9.3. INSTRUMENT CLEANING

Use a dry and soft cloth to clean the instrument. Never use wet cloths, solvents, water, etc.

10. TECHNICAL SPECIFICATIONS

10.1. TECHNICAL CHARACTERISTICS

Accuracy stated as \pm [%reading + (num. dgt*resolution)] at 23 °C \pm 5 °C, <80%RH

MULTIMETER FUNCTION

DMM – DC Voltage

Range [V]	Resolution [V]	Accuracy
3 ÷ 1500	1	$\pm(1.0\% \text{reading} + 2\text{dgt})$

I-V CURVE MEASUREMENTS AND IVCK TESTS

I-V, IVCK: DC Voltage (@ OPC)

Range [V]	Resolution [V]	Accuracy (*)
15.0 ÷ 1500.0	0.1	$\pm(0.2\%V_{oc})$

(*) In accordance with IEC/EN60904-1; Measurements start at VDC > 15V and with module capacitance <30 μ F

I-V, IVCK: DC Current (@ OPC)

Range [A]	Resolution [A]	Accuracy (*)
0.20 ÷ 40.00	0.01	$\pm(0.2\%I_{sc})$

(*) In accordance with IEC/EN60904-1; $I_{scmin} = 0.2A$ and module capacitance <30 μ F

I-V: DC Power (@ OPC) (VDC > 30V)

Range [W]	Resolution [W]	Accuracy
50 ÷ 9999	1	$\pm(1.0\% \text{reading} + 6\text{dgt})$
10.00k ÷ 59.99k	0.01k	

VDC voltage $\geq 30V$ and module capacitance <30 μ F

I-V, IVCK: DC Voltage (@ STC)

Range [V]	Resolution [V]	Accuracy
3.0 ÷ 1500.0	0.1	$\pm 4.0\% \text{reading} + 2\text{dgt}$

I-V, IVCK: DC Current (@ STC)

Range [A]	Resolution [A]	Accuracy
0.20 ÷ 40.00	0.01	$\pm 4.0\% \text{reading} + 2\text{dgt}$

I-V: DC Power @ STC (referred to 1 module)

Range [W]	Resolution [W]	Accuracy
50 ÷ 9999	1	$\pm(4.0\% \text{reading} + 2\text{dgt})$

Module capacitance <30 μ F

10.2. GENERAL CHARACTERISTICS

Reference guidelines

Instrument safety:	IEC/EN61010-1, IEC/EN61010-2-030
EMC:	IEC/EN61326-1
Technical literature:	IEC/EN61187
Safety of measuring accessories:	IEC/EN61010-031
Measurements:	IEC/EN60891, IEC/EN60904-1-2 (I-V curves) IEC/EN62446, IEC/EN60904-1-2 (IVCK test)
PV module temperature (Auto):	IEC/EN60904-5
EMC environment of use:	portable, Class A, Group 1
Insulation:	double insulation
Level of pollution:	2
Measurement category:	CAT III 1500VDC, max. 1500VDC between inputs

Radio

Compliance with RED directive:	ETSI EN300328, ETSI EN301489-1, ETSI EN301489-17
--------------------------------	---

Display, memory and PC interface

Type of display:	TFT colour, 7", capacitive touch screen, 800x480pxl
Memory type:	Memory card, max. 32GB (non-expandable)
Internal database:	ca 63.000 modules can be saved
Saved data:	9999 IVCK tests or I-V curve
PC interface:	USB-C and WiFi
Interface with SOLAR03:	Bluetooth connection (up to 100m/328Ft free space)

Power supply

Internal power supply:	8x1.5V type AA LR06 alkaline batteries or 8x1.2V type AA rechargeable NiMH batteries
External power supply:	100-440VAC/15VDC, 50/60Hz external power supply CAT IV 300V (use HT power supply only)
Consumption:	8W
Low battery indication:	symbol  is displayed
Charging time:	approx. 4 hours
Battery life (@ 0°C ÷ 40°C):	8 hours under the following conditions: <ul style="list-style-type: none"> ➤ Battery capacity: 2000mAh ➤ PV string voltage: 800V ➤ Work cycles: 80 measurements/hour ➤ Instrument connected for 30s/measurement ➤ Instrument disconnected for 15s/measurement
Auto power off:	1 ÷ 10min selectable (can be disabled)

Mechanical characteristics

Dimensions (L x W x H)	336 x 300 x 132mm (13 x 12 x 5in)
Weight (batteries included):	5.5 kg (11lb)
Mechanical protection:	IP40 (case open), IP67 (case closed)

10.3. ENVIRONMENTAL CONDITIONS FOR USE

Reference temperature:	23° ± 5°C (73°F ± 41°F)
Working temperature:	-10°C ÷ 50°C (14°F ± 122°F)
Permitted relative humidity:	<80%RH
Storage temperature:	-20°C ÷ 60°C (-4°F ± 140°F)
Storage humidity:	<80%RH
Max operating altitude:	2000m (6562Ft)

**This instrument complies with the requirements of the Low Voltage Directive 2014/35/EU (LVD) and the EMC Directive 2014/30/EU and RED Directive 2014/53/EU
This instrument satisfies the requirements of 2011/65/EU (RoHS) directive and 2012/19/EU (WEEE) directive**

10.4. ACCESSORIES

See the attached packing list

**CAUTION**

Only the accessories supplied with the instrument guarantee compliance with the safety standards. They must be in good condition and must be replaced, if necessary, with identical models

11. APPENDIX

11.1. THEORETICAL ASPECTS OF THE I-V CURVE MEASUREMENT

The instrument is designed to perform tests and measurements on **PV modules** consisting of a suitable number of **PV cells** in order to determine their I-V (Current-Voltage) characteristic, which identifies them constructively, based on the reference standard IEC/EN60891

Tests can be performed either on individual modules or on a **PV string** (a set of PV modules), the set of which forms what is commonly known as a "PV generator", which is an integral part of a Single-phase or Three-phase PV installation

11.1.1. Theoretical Aspects of I-V Curve measurement

The I-V curve test is performed as described below:

- The meter performs the I-V curve measurement of the PV module connected to it, further to the real time measurement of irradiance and module temperature
- The measurement result is automatically "translated" to the Irradiance **Standard Test Condition (STC)** equal to **1000W/m²** and module temperature equal to **25°C**. In order to obtain accurate results in accordance with this manual, it is recommended that the specifications in § 10.1
- The instrument makes a comparison between the maximum rated power, with the percentage tolerance margin declared by the module manufacturer and included in the database for the module type selected on the meter (§ 6.3.1), and the measured value
- If the comparison is within the declared tolerance, the final result of the test will be "OK"; if not, the result will be "NOT OK" and the module will therefore not meet the specifications declared by the manufacturer (§ **Errore. L'origine riferimento non è stata trovata.**)

11.2. TYPICAL ERRORS ON I-V CURVES AND TROUBLESHOOTING

Measurement	Event	Troubleshooting
Good measurement 	<ul style="list-style-type: none"> The measured curve extrapolated to STC (blue) and the curve as declared by the manufacturer (black) of the modules match. 	<ul style="list-style-type: none"> No error, save data and move to next string to test
Low short circuit current 	<ul style="list-style-type: none"> Irradiance sensor oriented differently than the string under test Reflections on the irradiance sensor Wrong module selection at configuration of PV system Environmental contaminants on modules (soiling, dirt, snow, debris) Far distance obstruction (shading) Aging 	<ul style="list-style-type: none"> Orient the irradiance sensor properly Set the instrument properly Clean the modules Remove the obstructions Check the modules for blindness, humidity, etc. Replace affected modules
High short circuit current 	<ul style="list-style-type: none"> Irradiance sensor oriented differently than the string under test Reflections on the irradiance sensor Dirt on the irradiance sensor Wrong module selection at configuration of PV system Irradiance sensor defect 	<ul style="list-style-type: none"> Orient the irradiance sensor properly Clean the irradiance sensor Remove the obstructions Check the irradiance sensor for blindness, humidity, etc. Set the instrument properly Replace affected sensor
Low open circuit voltage 	<ul style="list-style-type: none"> Low temperature measurement Wrong numbers of module selection at configuration of PV system Shorted bypass diodes 	<ul style="list-style-type: none"> Attach the thermocouple properly to a typical temperature location Select the AUTO mode Set the instrument properly Replace affected modules
Low current ratio I_{mpp}/I_{sc} 	<ul style="list-style-type: none"> Soiling across modules Tapered shades Small current mismatch Degradation of cell shunt resistance 	<ul style="list-style-type: none"> Clean the modules Un-shade the modules Check that currents match Replace affected modules

<p>Low voltage ratio V_{mpp}/V_{oc}</p>	<ul style="list-style-type: none"> • Voltage drop on cables to PV module string 	<ul style="list-style-type: none"> • Check cables, connectors, contacts, and string wirings • Check cable length and cross section • Check modules for bad connections or oxidation • Replace affected modules
<p>Steps in the I-V curve</p>	<ul style="list-style-type: none"> • Small or partial shading of one module of the string under test • Reflections • Random environmental contaminants on modules (soiling, dirt, snow, debris, etc.) • Strong current mismatch • Cracks of cells or glass 	<ul style="list-style-type: none"> • Remove the obstructions • Remove obstructions • Re-test when un-shaded • Clean the modules • Check that currents match • Replace affected modules
<p>Characteristic curve not linear</p>	<ul style="list-style-type: none"> • Unsteady irradiation during measurement • Leopard spot clouds shading the modules • Low irradiation during measurement 	<ul style="list-style-type: none"> • Re-test when clouds are gone • Repeat measurement at an irradiation of minimum $700W/m^2$ (IEC/EN61829)

12. SERVICE

12.1. WARRANTY CONDITIONS

This unit is guaranteed against defects in materials and workmanship in accordance with the General Conditions of Sale. During the warranty period, all defective parts may be replaced and the manufacturer reserves the right to repair or replace the product.

If the instrument is to be returned to the after-sales service or to a dealer transportation costs shall be borne by the Customer. However, shipment must be agreed upon. Any instrument returned must be accompanied by a report stating the reasons for the return. Only the original packaging material can be used to ship the instrument; any damage caused by non-original packaging will be charged to the Customer. The manufacturer declines all responsibility for damage caused to persons and/or property.

The warranty does not apply in the following cases:

- Repair and/or replacement of accessories and battery (not covered by warranty).
- Any repairs that may be required as a result of misuse of the unit or use with incompatible equipment.
- Any repair that may be required as a result of improper packaging.
- Any repair that may be required as a result of servicing by unauthorised personnel.
- Any modification made to the equipment without the manufacturer's authorisation.
- Any use not specified in the specifications of the instrument or in the instruction manual.

The contents of this manual may not be reproduced in any form whatsoever without the authorisation of the manufacturer.

All our products are patented and their trademarks registered. The manufacturer reserves the right to modify the product specifications and prices if this is aimed at technological improvements.

12.2. SERVICE

If the instrument does not operate properly, before contacting the after-sales service check cables as well as test leads and replace them if necessary. If the unit continues to malfunction, check that it is being used correctly and as instructed in this manual. If the instrument is to be returned to the after-sales service or to a dealer, the transport costs shall be borne by the Customer. However, shipment must be agreed upon. Any instrument returned must be accompanied by a report stating the reasons for the return. Use only the original packaging material for shipping; any damage caused by non-original packaging will be charged to the Customer

