



EN

Operating Instructions Pressure Sensor including Temperature

PTS 500

I. Foreword



Read these operating instructions carefully and completely before installation, commissioning and maintenance work. Follow the instructions to ensure safe operation and proper functioning.

The operating instructions must always be available at the place of use. It is not permitted to make only individual pages available.

II. Table of contents

I... Foreword 2

II... Table of contents 3

1... Scope of delivery 5

2... Device overview 5

3... Type plates 6

4... Intended use 7

5... Use contrary to the intended purpose 7

6... Safety provisions 7

 6.1 Warning and information symbols used in these instructions 7

 6.2 Warnings 8

 6.3 General safety instructions 8

 6.4 Spare parts/accessories 11

 6.5 Environmental protection 11

7... Product information 12

 7.1 PTS 500 sensor types for the following pressure ranges 12

 7.2 Product features 12

 7.3 Function 12

8... Technical data 13

 8.1 Technical data and ambient conditions 13

 8.2 Dimensions of PTS 500 14

9... Installation of pressure sensor PTS 500 14

 9.1 Installation in pipe: PTS 500 15

 9.2 Rotate the operating unit by 180° 17

10. Electrical connection 18

 10.1 Service interface (Modbus-RTU, analogue output 4...20 mA 18

 10.2 Ethernet / Ethernet PoE (Power over Ethernet) 20

11. Commissioning 21

 11.1 Switch on sensor 21

12. Operation 22

13. Settings menu 22

 13.1 Call up the settings menu 23

14. Sensor setup 24

 14.1 Units 24

 14.2 Pressure offset setting 25

 14.3 Offset temperature setting 26

15. Settings advanced	27
15.1 Service interface (Modbus-RTU)	27
15.2 Switch/alarm output	28
15.3 User	29
15.3.1 Settings menu password, 4-digit	29
15.3.2 Language	29
15.3.3 Display brightness / Display rotate	30
15.4 Analogue output setting 4...20 mA	31
15.4.1 Channel 1	31
15.4.2 Status	31
15.4.3 Unit	31
15.4.4 Scaling 4 mA and 20 mA	32
15.4.5 Fault current	32
16. Network (Ethernet) settings	33
16.1 IP address	33
16.2 Modbus-TCP setup	33
17. Info	34
18. Status and error messages	35
18.1 Status messages	35
18.2 Error messages	35
19. Maintenance	36
19.1 Maintenance	36
19.2 Spare parts and repair	36
20. Disassembly	36
21. APPENDIX	37
21.1 Modbus-RTU settings (2001...2005)	37
21.2 Values Register PTS 500	37
21.3 Index Units	38
Declaration of conformity	39

1 Scope of delivery

- Pressure sensor PTS 500 for pressure and temperature measurement
- M12 connector socket, 5-pin, A-coded
- Calibration certificate
- These operating instructions

2 Device overview



- 1 Control/operating unit
- 1.1 Cover with display (rotatable 180°)
- 2 Connector A (Power Supply, Modbus-RTU, 4...20 mA)
- 3 Connector B (Pulse, MBus, Ethernet)
- 4 Sensor unit
- 5 Selection button (UP)
- 6 ENTER/OK button

3 Type plates

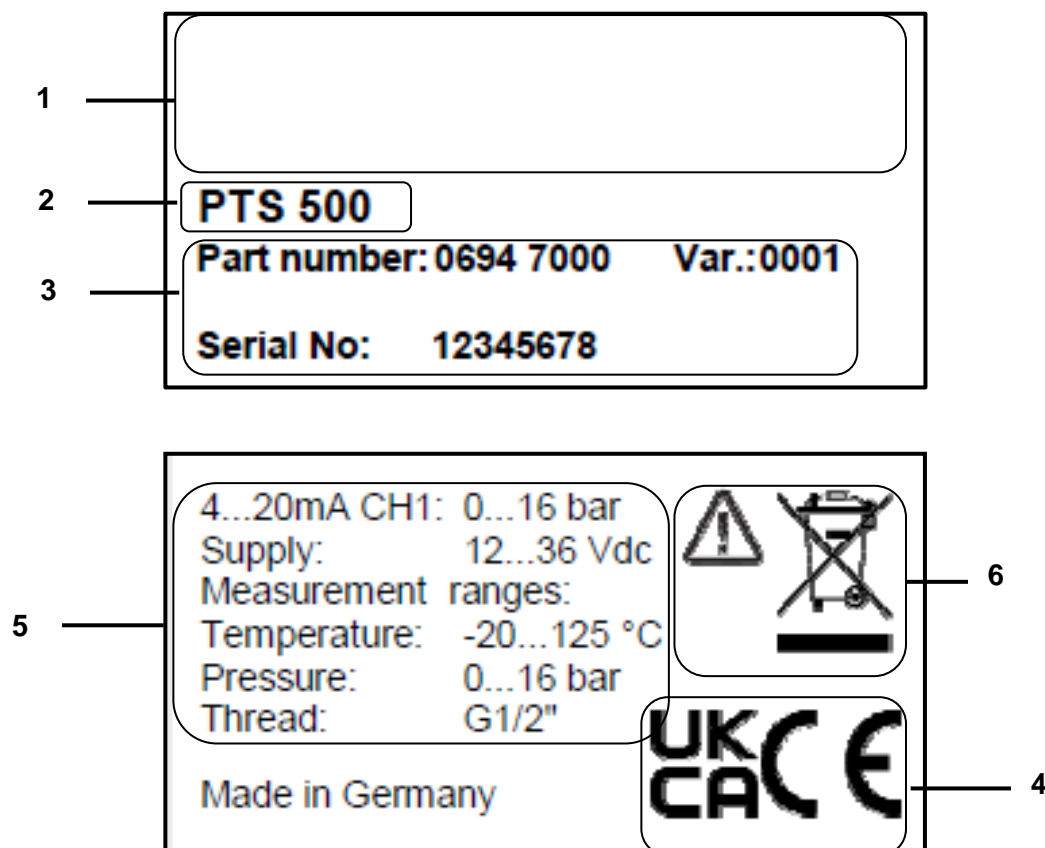

1 – Manufacturer info

2 – Sensor name

3 – Order numbers, serial number, production date

4 – Conformity/certification marking

5 – Electrical connection data:

e.g. available inputs and outputs, supply voltage

6 – Warning notice "Operating instructions must be observed".

4 Intended use

Pressure sensor PTS 500 is a measuring probe used to measure the pressure and temperature of gaseous fluids (compressed air, nitrogen) in the compressed air line.

The maximum permissible operating pressure for the PTS 500 is 1 bar/14.5 psig...50 bar/725 psig, depending on the type variant.

The temperature measuring range is -20 °C to + 200 °C/-4...392 °F with a maximum medium temperature at the pressure sensor of 125 °C/257 °F.

Operation of the PTS 500 is only permitted in the following cases:

- Only use the sensor indoors.
The sensor must be protected from direct sunlight, rain, splash water and excessive dust.
- In pipes with non-corrosive, gaseous fluids (compressed air, nitrogen) with clean, dry and oil-free properties.
- According to the technical data and approved ambient conditions.
- With correct calibration → chapter 22.2.

5 Use contrary to the intended purpose

Misuse when used as a climbing aid! The pressure sensor can be damaged. Danger of slipping. Select the installation location so that the pressure sensor cannot be used as a climbing aid. Never use the pressure sensor as a step or climbing aid.

6 Safety provisions

6.1 Warning and information symbols used in these instructions



In these operating instructions, this symbol is found next to all work safety instructions where there is danger to life and limb. Observance of these instructions and cautious behaviour are particularly important in these cases. All work safety instructions must also be shared with other users. In addition to the instructions in these operating instructions, the general safety and accident prevention regulations must be observed.

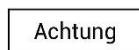

This symbol is located at points in the operating instructions where special attention must be paid to ensure that the guidelines, regulations, instructions and the correct procedure for the work are observed and that damage and destruction are prevented.



This symbol indicates important information or measures for the protection of the environment.



This symbol indicates particularly important information for operators.

6.2 Warnings

Warnings are subdivided according to the hazard levels **DANGER**, **WARNING** and **CAUTION**. Meaning of the warnings:



DANGER
Immediate danger!

▶ Failure to observe this information may result in serious injury or death.



WARNING
Potentially dangerous situation!

▶ Failure to observe this information may result in serious injury or death.



CAUTION
Potentially dangerous situation!

▶ Failure to observe this information may result in moderate to minor injuries.



NOTE
Potentially dangerous situation!

▶ Failure to observe this information may result in property damage.

6.3 General safety instructions

Important notes for installation and maintenance personnel

The pressure sensor may only be installed by trained specialists with knowledge and experience in compressed air and electrical engineering.

Electrical connection, commissioning and maintenance are only to be carried out by qualified electricians in accordance with the electrotechnical regulations (DIN EN 50110-1, DIN EN 60204-1 and so on). Prerequisite for the specialist personnel: Technical training and knowledge of technical standards, EU directives and EU regulations.

The applicable national accident prevention regulations and ordinances and general occupational health and safety measures must be observed, including the wearing of suitable and prescribed personal protective equipment (PPE).

Only the manufacturer is permitted to perform repairs and adjustments. Installation and maintenance by trained specialist personnel.

Obligations of the installer and system operator

The pressure sensor must be checked and maintained regularly by a trained and qualified individual → chapter 22.

Cleaning and maintenance intervals are to be determined by the system operator in accordance with DIN-ISO certification – frequency depending on ambient conditions and anticipated considerations.

Keep an identical replacement sensor ready for use in systems that are essential for operation.



NOTE

Without the consultation and approval of the warranty claim is void in case of conversion work which is not listed in these operating instructions. This symbol is located at points in the operating instructions where special attention must be paid to ensure that the guidelines, regulations, instructions and the correct procedure for the work are observed and that damage and destruction are prevented.

Obligations of the installer of the system: The installer of the system is responsible for the safety of the system in which the PTS 500 is installed. Pay particular attention to the technical data and ambient conditions (chapter 8) and the information on the electrical connection and prescribed connection cables (chapter 10).

Only use pressure sensor PTS 500 as intended.

Risk of injury and accidents when operating outside the permissible ambient/operating conditions or operating temperatures due to overpressure or faulty installation. Comply with maximum permissible operating pressure. Ensure that the pressure sensor is only operated within the permissible limit values (→ type plate).

Risk of injury due to unauthorised unit modifications, incorrect installation or damaged components. The operating licence expires in these cases. **Operation is only permitted with original components.** Only operate the pressure sensor when it is completely assembled. Do not operate a damaged sensor, and prevent further use of the sensor until it is repaired. The sensor must be checked and maintained regularly by trained and qualified individuals. Device modifications are not permitted and release the manufacturer from any warranty and liability.

Dirt particles in the compressed air will cause measurement errors. Dirt particles and liquids can contaminate the sensor element and lead to malfunction or failure. The system operator must ensure the prescribed purity of the fluids approved for the application as well as appropriate cleaning and maintenance intervals. The manufacturer provides no warranty and accepts no liability of any kind with regard to misuse.

Explosion hazard in potentially Ex-protective zones due to ignition of explosives when sparks are generated. The pressure sensor does not have Ex approval! Do not use the pressure sensor in Ex-protective zones.

Ensure clean compressed air without harmful components. Harmful components include explosive or chemically unstable gases and vapours, acid or base-forming substances such as ammonia, chlorine or hydrogen sulphide and condensates or oils and oil vapours.

Password protection in the settings menu: Password protection is provided to protect against unauthorised entries/settings of the system parameters. For setting the password → chapter 17.1.

Danger of burns from hot sensor. Hot air/gas/gas mixtures in the pipe can warm up or heat the pressure sensor. Only touch the sensor when it has cooled down. If applicable, use protective gloves.

Danger to life from escaping compressed air if it is directed at people, especially at high pressure. For assembly, maintenance and calibration work, depressurise the system and check the depressurised state. For the PTS 500, install a shut-off valve in the compressed air line before and after the pressure sensor so that the pressure sensor can be removed quickly and easily for maintenance/calibration purposes. **Ensure proper installation.**

Danger if the applicable regulations for electrical installations are not observed. For electrical installation, observe the applicable regulations, e.g. DIN EN 50110-1. In Germany observe in particular VDE 0100 in the relevant parts. Observe local regulations. Before working on the electrical installation, switch off all supply circuits, switch off the mains fuse and secure against being switched on again. Ensure voltage-free status. Operate the pressure sensor only with permissible connection cables for the mains supply and bus connection → technical data. Establish the electrical connection according to the wiring diagram (→ chapter 10).

Exercise due care when handling packaging materials. Comply with applicable safety and accident prevention regulations. Keep packaging material out of reach of children (choking hazard if foil or small parts are swallowed).

Seals/sealants: As a suitable sealant for the screw connections, sealing rings made of copper or aluminium, elastomer sealing rings with metal backing, sealing tape/sealing cord or other equivalent sealants that meet the demands of the required, necessary compressed air quality can be used.

6.4 Spare parts/accessories

Spare parts

- Cover with Display



NOTE
Only trained specialist personnel may replace the cover and display of the operating unit. To ensure measurement accuracy and operational safety, all other repairs may only be performed by the manufacturer.

NOTE

Keep an identical replacement sensor ready for use in systems that are essential for operation.



6.5 Environmental protection

The pressure sensor as well as the packaging contain recyclable materials that should not be disposed of in the residual waste. At the end of use, dispose of the packaging materials and pressure sensor in an environmentally friendly manner in accordance with the regulations in your country.

The operating materials and auxiliary materials consumed and any parts that are replaced during operation of the pressure sensor must be disposed of in accordance with environmental protection regulations.

Germany: Disposal code according to the Waste Catalogue Ordinance (AVV) **16 02 14**, electrical and electronic devices and their components.

7 Product information

7.1 PTS 500 sensor types for the following pressure ranges

- Up to max 0 bar (gauge) /0 psig
- Up to max 1.6 bar gauge/23.2 psig
- Up to max 10 bar gauge/145 psig
- Up to max 16 bar gauge/232 psig
- Up to max 50 bar gauge/725 psig

7.2 Product features

- Units can be selected as required: °C, °F, hPa, mbar, bar, psi
- Two-button input on the display
- 1x analogue output 4...20 mA, adjustable for pressure and temperature parameters
Optional: 2x analogue output 4..20mA
- Modbus of RTU interface (RS-485)
- **Optional:** Ethernet/Ethernet PoE and M-Bus
- Switching/alarm output, galvanically isolated. Alarm adjustable via keypad.
- IP 65 housing

7.3 Function

Pressure sensor PTS 500 continuously measures the pressure and temperature of the gaseous fluid (compressed air, nitrogen) in the pipe.

8 Technical data

8.1 Technical data and ambient conditions

Parameters	Pressure, temperature
Sensor principle	Pressure measurement
Available measuring ranges for overpressure (bursting pressure), depending on sensor type	0...1 bar/0...14.5 psi (abs) 0...1.6 bar gauge (6 bar)/0...23.2 psig (87 psi) 0...10 bar gauge (40 bar)/0...145 psig (580 psi) 0...16 bar gauge (60 bar) /0...232 psig (870 psi) 0...50 bar gauge (100 bar)/0...725 psig (1450 psi)
Pressure sensor accuracy	±0.5% f.s. (at 20 °C/68 °F) *
Measuring range of temperature sensor	-20...+125 °C/-4...257 °F
Medium temperature	-20...+125 °C/-4...257 °F
Accuracy of temperature	±1.0 °C/1,8 °F (-10...+50 °C/14...122 °F)
Ambient temperature	-20...60 °C/-4...140 °F
Storage temperature	-40...80 °C/-40...176 °F
Pollution level	Pollution level 2
Relative humidity (transport, storage, operation)	0% to 90% (non-condensing)
Operating height, storage height	0...2000m (0...6560 ft)
Mounting thread	G ½" or NPT ½"
Power supply	18 to 36 VDC via SELV supply, 5 W or Power over Ethernet according to IEEE 802.3af, class 2 (3.84...6.49 W). Fuse protection in supply unit T2.5L 125V
Signal output	Modbus-RTU (RS-485) 1x AO 4...20 mA (pressure or temperature) Optional: Modbus-TCP Ethernet M-Bus 2 x analogue output 4..20mA
Power consumption	Max. 6.5 W
Measured values with Modbus-TCP	Pressure (hPa, mbar, bar, psi,...) Temperature (°C, °F)
Electrical connection	2x M12 flush-type connector, 5-pin (A-coded) Option Ethernet: 1 x M12 socket, 8-pin (X-coded)
Protection class	IP 65

* of f.s. = of full scale

8.2 Dimensions of PTS 500

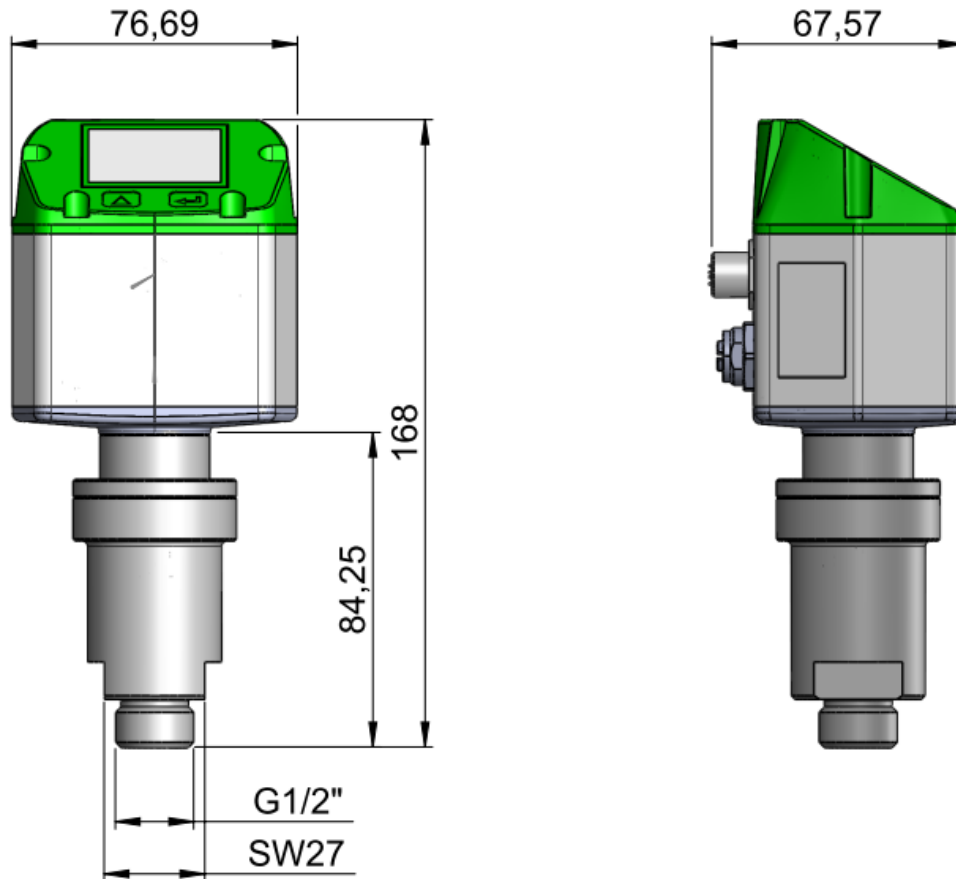

9 Installation of pressure sensor PTS 500



NOTES

▶ If necessary, rotate the display head of the operating unit 180° (→ chapter 9.2) or rotate the display (for reading direction, rotate the LCD upside down → chapter 17.3).

Clean/flush the pipes sufficiently after the installation work.

▶ Condensate and particles in the pipe can contaminate the sensor element and lead to faulty measurement results.



WARNING

Components under high pressure! Risk of injury if the pressure sensor is not installed in a pressure-tight manner.

▶ After installation, be sure to check and ensure the pressure tightness of the connection. Do not work directly over the sensor but next to it to minimise possible hazards.

9.1 Installation in pipe: PTS 500

Direct installation

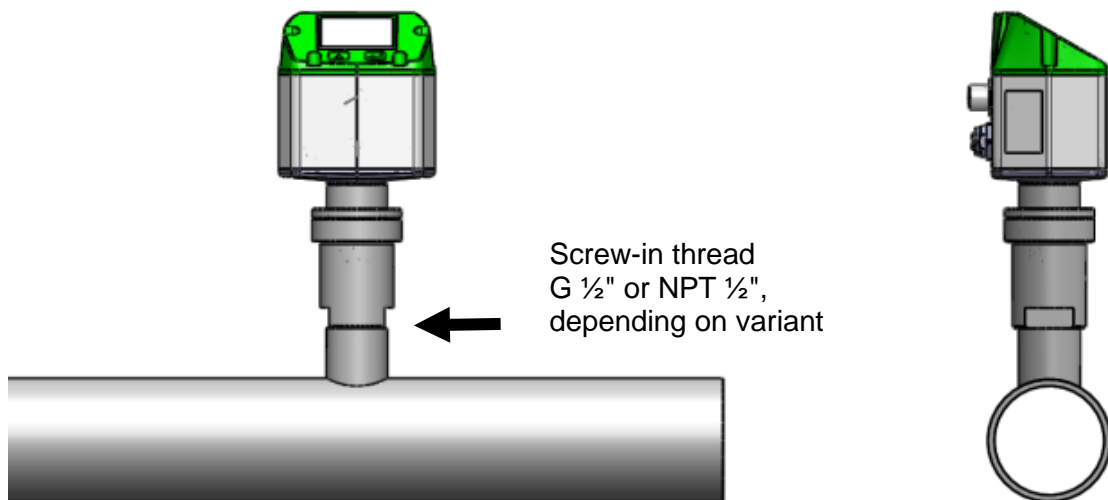

WARNING

Danger from pressurised components.

Before any work on the pipe system, depressurise the system.



NOTE

► If possible, install a shut-off valve on both sides of the pressure sensor. The pressure sensor can then be easily removed for installation, maintenance or calibration.

1. Attach the pipe connection with a suitable screw-in thread (G 1/2" or NPT 1/2", depending on the variant) at the installation site. Observe the safety instructions.
2. For G 1/2" threads, insert the flat gasket supplied. Ensure that it is undamaged and correctly attached.



CAUTION

Do not use flat gaskets for NPT 1/2" threads = leaky connection.

▶ Apply sealing material to the NPT 1/2" thread of the pressure sensor. Use only suitable PTFE sealing tape or sealant. Do not damage the thread.

3. Screw in the pressure sensor and tighten with a torque of 25...30 Nm.
4. Check and ensure the tightness of the connection.

Installation over ball valve

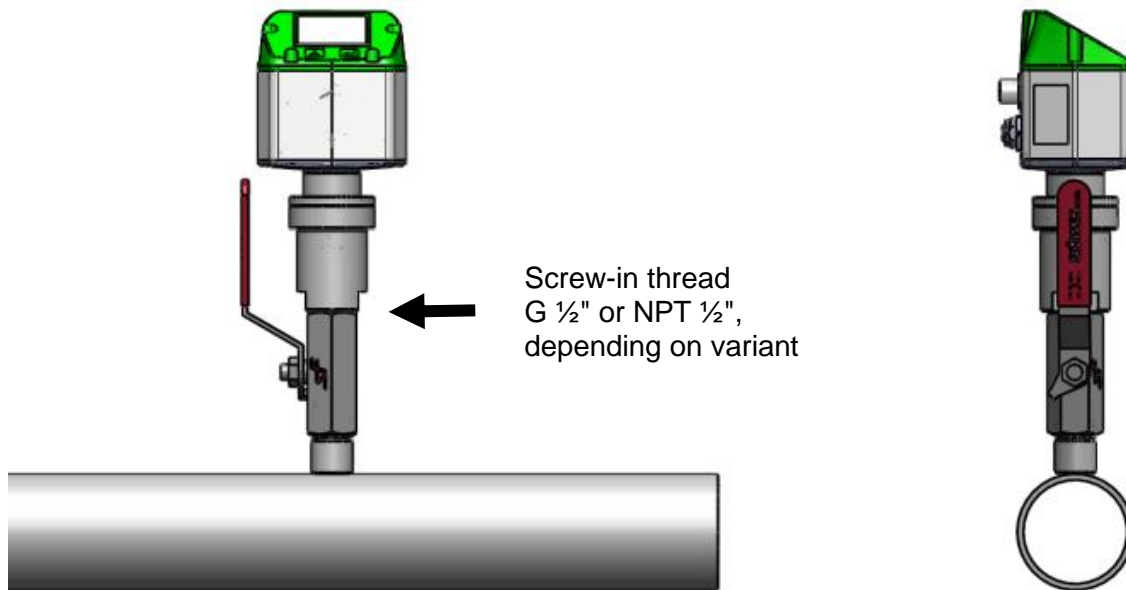

WARNING

Danger from pressurised components.

▶ After installation, be sure to check and ensure the pressure tightness of the connection. Do not work directly over the sensor, but next to it to minimise possible hazards.



NOTE

▶ With installation over a ball valve, a measured value deviation of the temperature can occur due to the increased distance.

1. Attach the ball valve with a suitable screw-in thread (G 1/2" or NPT 1/2", depending on the variant) at the installation site. Observe the safety instructions.
2. Close the ball valve.
3. For G 1/2" threads, insert the flat gasket supplied. Ensure that it is undamaged and correctly attached.



CAUTION

Do not use flat gaskets for NPT 1/2" threads = leaky connection.

▶ Apply sealing material to the NPT 1/2" thread of the pressure sensor. Use only suitable PTFE sealing tape or sealant. Do not damage the thread.

4. Screw in the pressure sensor and tighten with a torque of 25...30 Nm.
5. Check and ensure the tightness of the connection.

9.2 Rotate the operating unit by 180°

If desired, rotate the operating unit by 180°.



1. Loosen the six fastening screws [S] (Torx 10).
2. Pull up the operating unit and rotate it by 180°.



NOTE

▶ Malfunctions/damage to the unit may result if it is incorrectly installed. Check the position of the head gasket. Ensure that the connection cables can be correctly plugged into flush-type connectors [2] and [3].

3. Tighten the operating unit with the six fastening screws [S], tightening torque 5 Nm.

10 Electrical connection

Work on the electrical system may only be carried out by qualified electricians or other competent persons. For electrical installation, observe the applicable regulations, e.g. DIN EN 50110-1. In Germany observe in particular VDE 0100 in the relevant parts or other national regulations accordingly.

10.1 Service interface (Modbus-RTU, analogue output 4...20 mA)

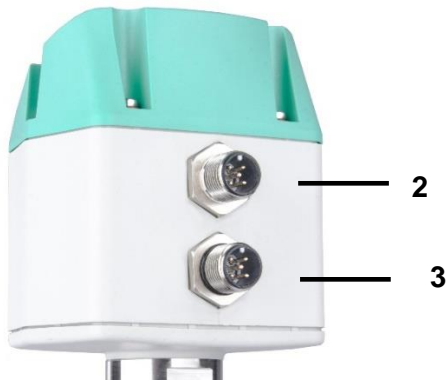

- 2 Connector A: Modbus-RTU, voltage/power supply, 4...20 mA output:
M12 flush-type connector, 5-pin, A-coded
- 3 Connector B: Pulse output, M-Bus interface
M12 flush-type connector, 5-pin, A-coded

Pre-assembled connection cables available as accessories.



NOTE

▶ Do **not** connect unneeded connections (NC) to potential and/or earth. Cut off unneeded cables and insulate them properly.

	Pin 1	Pin 2	Pin 3	Pin 4	Pin 5
Connector A	+VB	RS 485 (A) RS 485 (+)	-VB	RS 485 (B) RS 485 (-)	I+ (4..20 mA)
Connector B Pulse output (standard)	NC	GND	DIR	Alarm / Pulse galv. isolated	Alarm / Pulse galv. isolated
Connector B Option 2x 4..20mA	I+ (4..20 mA)	Alarm / Pulse galv. isolated	Alarm / Pulse galv. isolated	Alarm / Pulse galv. isolated	Alarm / Pulse galv. isolated
Connector B Option M-Bus	NC	Alarm / Pulse galv. isolated	Alarm / Pulse galv. isolated	MBus	MBus
Wire colour 0553.0106 (5 m) 0553.0107 (10 m)	Brown	White	Blue	Black	Grey

- VB Negative supply voltage 0 V
- +VB Positive supply voltage 18...36 VDC smoothed
- I + Current signal 4...20 mA – selected measuring signal
- Switching output relay output (normally closed), max. 48 V, 0.05 A
- RS-485 (A) Modbus-RTU A/Modbus-RTU (+)
- RS-485 (B) Modbus-RTU B/Modbus-RTU (-)

M12 connector plug

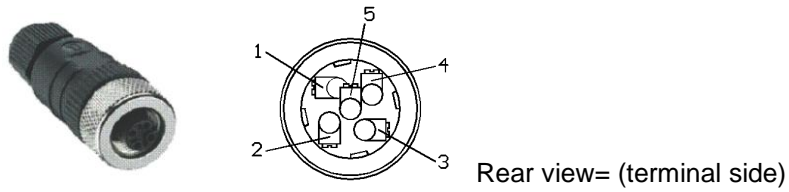

If no connection cable/pulse line has been ordered, the sensor is supplied with M12 flush-type connector, 5-pin, A-coded. The user can connect the signals as shown in the connection diagram.

Connector plug A [2]: M12 flush-type connector, A-coded

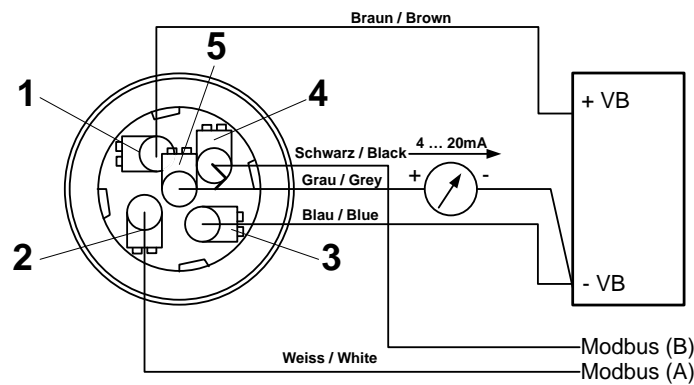

NOTE

▶ For Modbus-RTU setup → chapter 15 and tables in the appendix.

Connector plug B [3]: M12 flush-type connector, A-coded

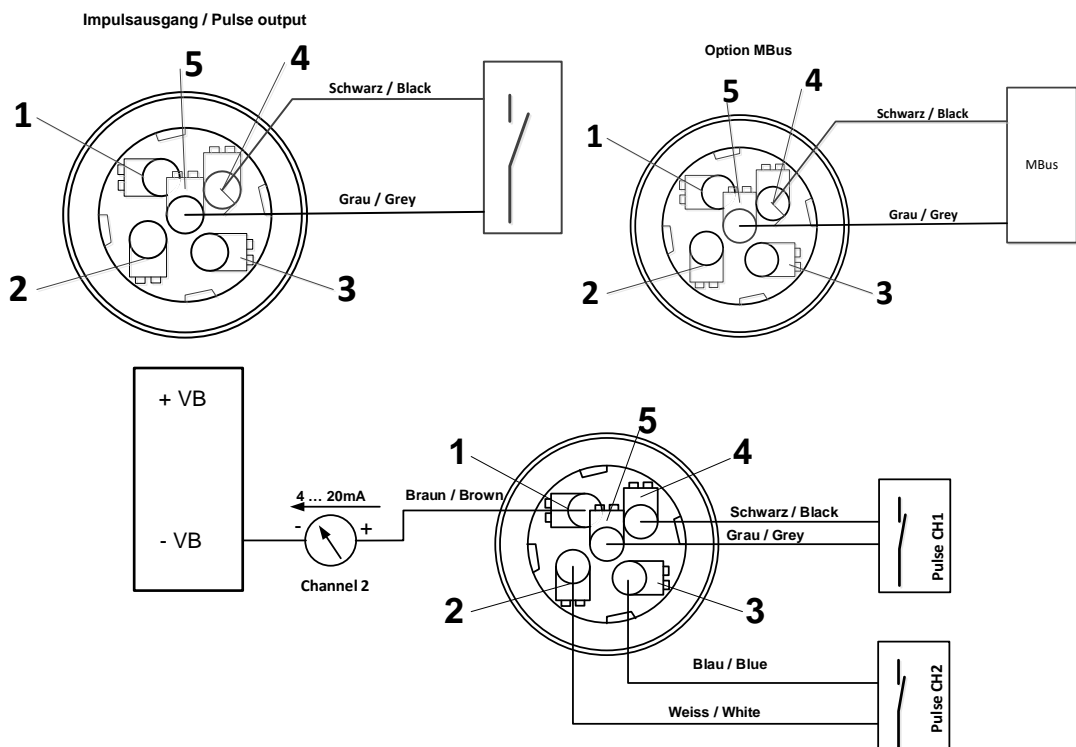

10.2 Ethernet / Ethernet PoE (Power over Ethernet)



- 3 Connector Ethernet / Ethernet PoE:
M12 Ethernet flush-type connector, X-coded



NOTE

Connector for Ethernet (PoE): M12 X-coded 8-pole (socket)
 ▶ Connection cable M12 D-coded (plug) to RJ45, data cables: 1,2 and 3,4 and PoE cables 5,6 & 7,8

Connector B [3]
M12 x-coded 8 pole

Connection cable
M12 x-coded to RJ45

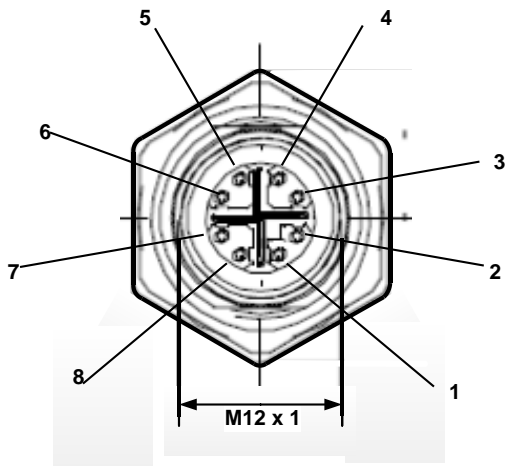

M12 jack

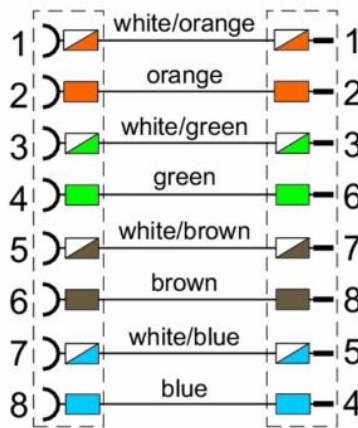
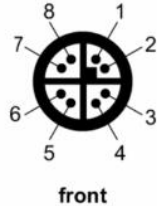

RJ45 plug

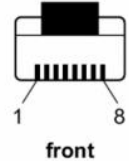

Shield connected

Connection cable: Cat 6.

Remark:

PTS 500 Power Classification acc. IEEE 802.3af: Class 2 (3,84W – 6,49W)

*PoE: Power over Ethernet

11 Commissioning



WARNING

Danger from pressurised components.

- ▶ Ensure sufficient and safe compressed air quality with a compressed air system. If operating pressures are too low over an extended period of time, the flow velocity in the pipe increases sharply. This can lead to major impairments in the compressed air preparation. Install a compressed air system to prevent this.
- ▶ When commissioning for the first time, ensure that the operating pressure is adapted to the consumer network.

11.1 Switch on sensor

1. Ensure that pressure sensor PTS 500 is correctly connected.
2. After connecting the power supply (initial start or after a reset), the pressure sensor switches on and carries out a device initialisation for approx. 2...3 seconds.

Start screen: Info page 1

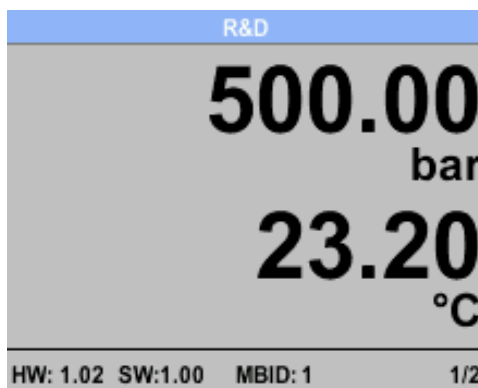

Line pressure (in bar/psi)
with current temperature (in °C)

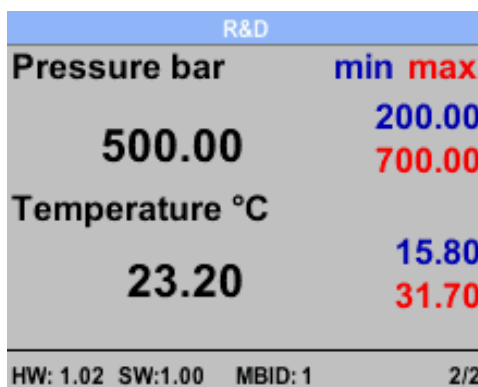

Press the  button to switch between the info pages.

Info page 2



Min/max values for overpressure and temperature

12 Operation

- You select a menu item, button field or input value with the  button.
- To reach the selected menu/button field or to confirm the input value, press the  button, depending on which menu/button field you are in.
- Pressing **Back** takes you to the menu above.

13 Settings menu

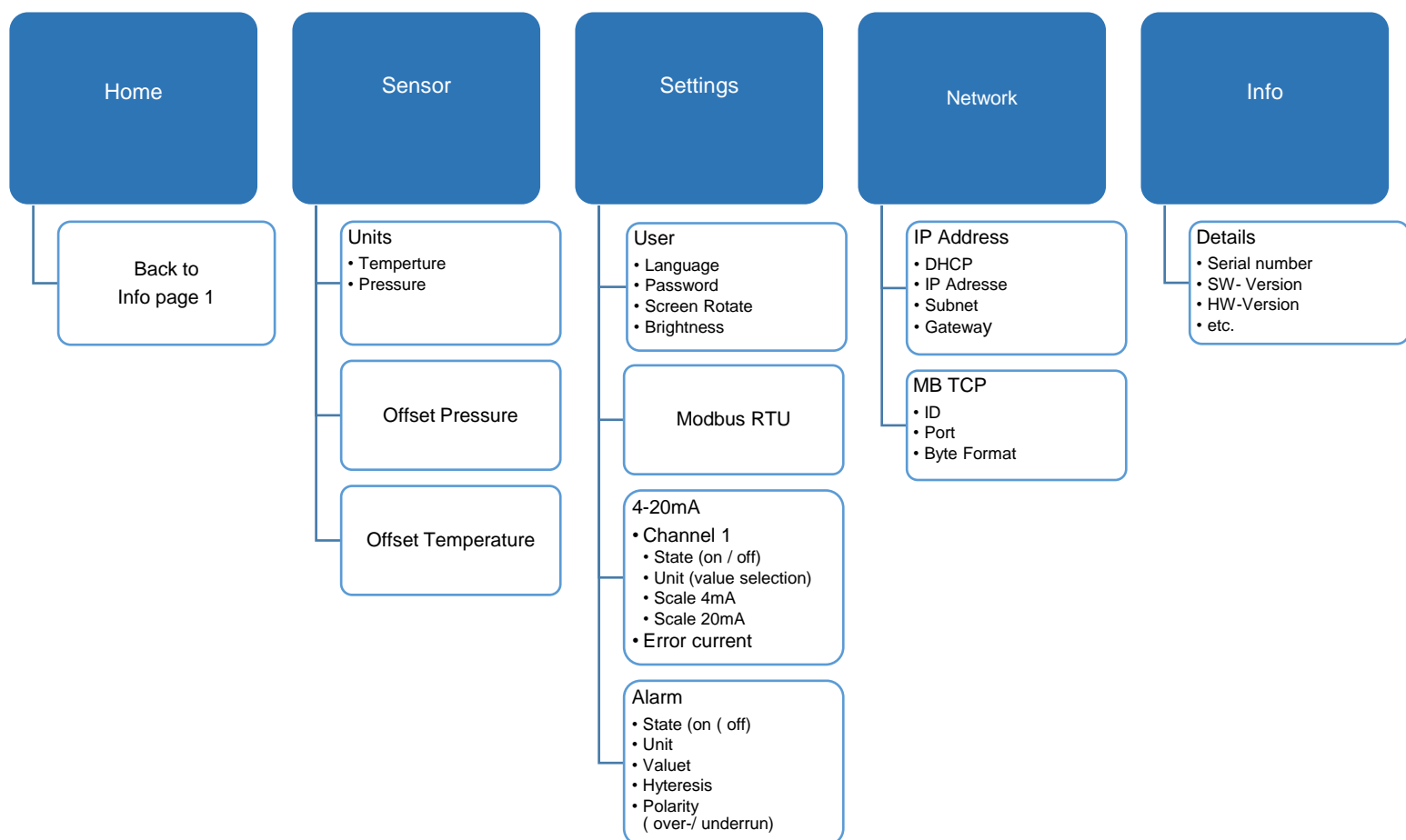

13.1 Call up the settings menu

**NOTE**

Password ex works = 0000. If the password has been changed and forgotten, access is granted with a master password.

**NOTE**

To assign a new password, select.
Settings → **User** → **Password**.

1. Press the  button.

The password input field appears.

2. Enter the 4-digit password.

3. Confirm with .

The **Settings** menu appears

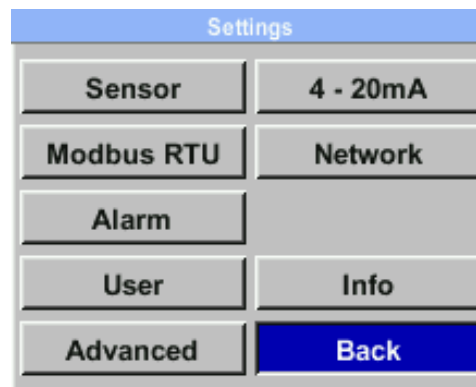

14 Sensor setup

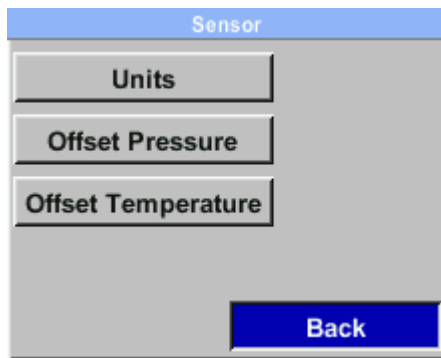

1. Select the **Sensor** menu in the Settings menu with  and confirm with .

Selection fields: Units, pressure and calibration

2. Press **Back** → main menu.

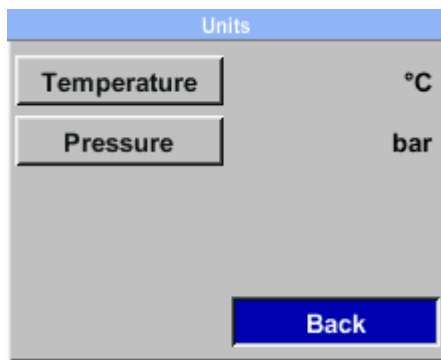

14.1 Units



Here you can set the units for **temperature** (°C, °F) and **pressure** (hPa, mbar, bar, psi, Mpa).

1. Select selection field with . Confirm with .

The currently set unit appears in the display field.

2. Select another unit with . Confirm with  2x.
3. Press **Back** → main menu.

14.2 Pressure offset setting

Offset Pressure	
Actual Value:	500.00 bar
Offset:	0.00 bar
set value to	reset
Back	

**NOTE**

Offset: The offset value is used to compensate for minor deviations between the signal value and measuring range value that may occur after prolonged operation.

Recommendation: Perform recalibration from time to time to ensure high accuracy.

**NOTE**

The offset value can be determined with a reference check or with a second pressure sensor.

1. To change the offset pressure, select the corresponding input field with and confirm with .
2. Select **Set value to** with . Confirm with 2x.
3. To enter a numeric field, select with and confirm with .
4. Increase the number value with . Confirm the entry with .
5. **CLR** resets the display to 0.
6. Press **OK** → accept the new value.
7. Press **Back** → save and return to the main menu.

14.3 Offset temperature setting

The screenshot shows a menu titled "Offset Temperature". It displays two rows of data: "Actual Value: 23.20 °C" and "Offset: 0.00 °C". Below the data, there are three buttons: "set value to" (a grey button with a white border), "reset" (a grey button with a white border), and "Back" (a blue button with white text).

**NOTE**

The offset temperature can be determined with a second thermometer.

1. To set the **Temperature Offset**, select the **Set value to** input field with and confirm with .
2. To enter a numeric field, select with and confirm with .
3. Increase the number value with . Confirm the entry with .
4. Use **Calibration** to accept the reference value entered, such as a comparison value for a newly calibrated pressure sensor or service sensor.
5. Reset to the factory settings with **Reset**.
6. Press **Back** → save and return to the main menu.

15 Settings advanced

15.1 Service interface (Modbus-RTU)

The pressure sensor is equipped with an RS-485 interface (Modbus-RTU)..

Only connect the sensor to the Modbus after completing the following adjustment tasks:

1. If the pressure sensor is installed at the end of the Modbus line, terminate it (if not → point 2.). To do this, set the internal **switch to ON**. Alternatively, a 120R resistor can be installed in the plug between pin 2 and pin 4 → chapter 10, Electrical connection. To open the operating unit, → chapter 9.2.

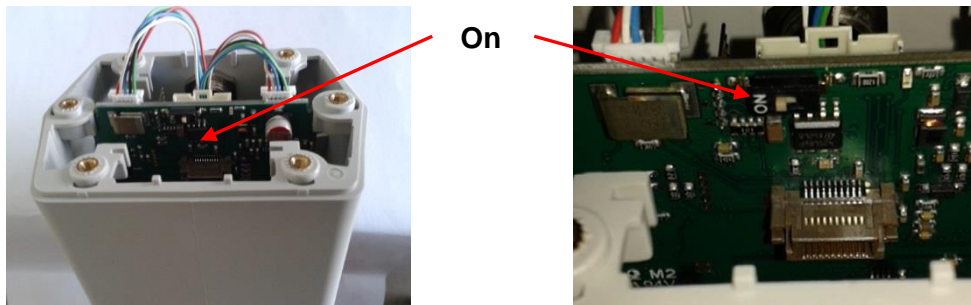







2. Check Modbus parameter values and adjust if necessary

Settings → Modbus RTU

Interface parameters	Factory setting
• Modbus ID/sensor ID	1
• Baud rate	19200
• Stop bit	1
• Parity	even
• Byte format	ABCD

Set ID, baud rate, stop bit, parity and byte format

3. Use  to select the desired selection field and confirm with .
4. Use  to select the desired numeric field and confirm with .
5. Set the value with  and accept with .
6. Press **Save** to save the setting.
7. Press **Back** → main menu.



NOTE

Byte format allows you to set the data format (word order). To change available formats = ABCD (Big Endian) and CDAB (Middle Endian).



Reset to factory setting with **set default values**.

If the parameters between the master and slave are different, there is **no communication** between the units.

8. Only now connect the pressure sensor to the Modbus.

15.2 Switch/alarm output





After calling up the menu, the first field is activated (blue background).

1. Use  to set the **Alarm menu** as an **Alarm output** and confirm with .
2. Make further settings for the alarm:
Selection fields: Unit, value, hyst., fall below/exceed
3. Press **OK** → main menu.



Selection fields

- Units: °C, °F, hPa, mbar, bar, psi
- Value defines the alarm value
- Hyst. defines the desired hysteresis
- Exceed/fall below determines when the alarm responds:
exceed = exceeding value/fall below = falling below value



Setting

1. Use  to select the desired selection field and confirm with .
2. **Button**  to move to the next data field or position or to change the setting value and confirm each with .
3. Press **Save** to accept the setting.

15.3 User

1. Select the **User** menu in the Settings menu with  and confirm with .

Selection fields: Password, Language, Display brightness and Display rotate



2. Use  to select the desired selection field and confirm with .

15.3.1 Settings menu password, 4-digit



NOTE

Password ex works = 0000. If you have forgotten the password, you can gain access with a master password.

1. Use  to select the **Password** selection field and confirm with .
2. Enter a new password. To do this, press one of the **numeric buttons** and confirm with . Set the other three digits in the same way.

Press the  button to delete the last digit.



3. Enter the **password a second time** and confirm with .

The new password is now valid.



4. Press **Back** → main menu.







15.3.2 Language



Here you can select one of the four stored languages: German, English, Spanish, French – default setting = German.

1. Use  to select the desired **language** and confirm with .
2. Press **Back** → main menu.

15.3.3 Display brightness / Display rotate

The brightness on the display can be adjusted in % steps with  and  → bar chart. To reduce energy consumption, dimming makes the screen dim after the time that has been set elapses.

1. Use  and  to adjust the screen brightness.
2. Use  to select the desired **time** (in min.) and confirm with .
3. If the control is mounted rotated by 180°, rotate the display 180° with **Rotate LCD**.
4. If the sensor is to be operated exclusively using the bus system, both the  and  operating buttons can be locked here.



The two operating buttons  and  are unlocked within 10 seconds after the pressure sensor has been restarted and the **Settings menu** has been called up with .

5. Press **Back** → main menu.

15.4 Analogue output setting 4...20 mA



1. Select the **4...20 mA** field in the Settings menu with  and confirm with .

Selection fields: Channel 1 and fault current





2. Use  to select the desired selection field and confirm with .
3. Press **Back** → main menu.

15.4.1 Channel 1





Parameter selection fields: Status, unit, scaling 4 mA and scaling 20 mA

1. Use  to select the desired parameter and confirm with .
2. Make further settings.
3. Press **Back** → main menu.



15.4.2 Status

1. Use  to select the desired field and confirm with :
on activates the alarm output, **off** deactivates the alarm output.
2. Use  to select the desired unit and confirm with .
3. Press **Save** to accept the setting. Press **Cancel** to discard the change.
4. Press **Back** → settings menu 4 – 20 mA.



15.4.3 Unit

1. Use  to select the unit field and confirm with .
2. Use  to select the desired unit and confirm with .
3. Press **Save** to accept the setting. Press **Cancel** to discard the change.
4. Press **Back** → settings menu 4 – 20 mA.

16 Network (Ethernet) settings

1. Select the **Network** menu in the Settings menu with  and confirm with .

Selection fields: IP address, Modbus-TCP

2. Use  to select the desired selection field and confirm with .
3. Press **Back** → main menu.

16.1 IP address





Network address to a computer, **with** or **without DHCP**.



NOTE

With the DHCP protocol activated, automatic integration of the sensor into an existing network is possible without configuring it manually.

Set static IP, subnet and gateway



1. Use  to select the desired selection field (data field is highlighted in blue) and confirm with .
2. Use  to change the input value and confirm with .
3. Press **Button** > to move to the next data field or next position or to change the setting value, and confirm each with .
4. Press **Save** to accept the setting.

16.2 Modbus-TCP setup

The pressure sensor is equipped with a Modbus-TCP interface:

- HW interface M12 X-coded
- TCP port = 502, setting on the sensor
- Modbus unit address (unit identifier) 1...255
- Supported Modbus commands/functions:
Function code 3: Read holding register
Function code 16: Write multiple registers
-

Set ID, port and byte format

1. Use  to select the desired selection field and confirm with .
2. Press **Button** > to move to the next data field or next position or to change the setting value, and confirm each with .
3. Press **Save** to accept the setting.



NOTE

Byte Format allows you to set the data format (word order).
 Formats available for selection: ABCD (Big Endian) and CDAB (Middle Endian).

Reset to factory setting with **set default values**.

17 Info

Access the info menu 

Press **Back** → main menu

Info	
Serial No.:	00000123
Cal. Date:	10.01.2013
Sensor Type:	PTS
Software Version:	1.30
Hardware Version:	1.01
Run Time:	0d 0h 00m 00s
VIn:	24.0 V
Back	

18 Status and error messages

18.1 Status messages

CAL

The status message **CAL** appears in the status line (red) after the recommended re-calibration interval has expired.



NOTE

Calibration: A (re)calibration is to be carried out depending on operational specifications and any intended DIN ISO certifications. Regular calibration is usually recommended after 2 years or at intervals determined by the operator.

18.2 Error messages

Low voltage

appears if there is a supply voltage of < 11 V. The pressure sensor will no longer measure properly. No measured values are available.

Troubleshooting: Check supply voltage. Ensure supply voltage ≥ 11 V.

Internal Error

Appears if an internal read error is registered (EEProm, AD converter, and so on).

Troubleshooting: Remove the pressure sensor .

Temp out of range

Appears if the temperature of the medium is outside the specified temperature range. This leads to faulty measured values outside the sensor specifications.

Troubleshooting: Check medium temperature. If this is OK, remove the dew point sensor .

Low Voltage 4...20 mA

Appears if the minimum supply voltage of 17.5 V is not reached.

Troubleshooting: Check supply voltage. Ensure supply voltage ≥ 18 V.

19 Maintenance



NOTE

▶ The pressure sensor may only be removed by trained specialist personnel. Observe the safety instructions.



WARNING

Risk of injury from pressurised components in case of overpressure/bursting.

▶ Remove the pressure sensor without quick coupling only in a depressurised state. Check and ensure a depressurised state.

1. Ensure the depressurised state in the area of the pressure sensor.
Close the ball valves on both sides of the pressure sensor or depressurise the system. Exception: When using a quick coupling.
2. Remove the pressure sensor.
3. For reinstallation → chapter 9.

19.1 Maintenance

The pressure sensor requires little maintenance.



NOTE

Dirt particles in the compressed air cause measurement errors. A dirty sensor element can lead to a malfunction or failure. The pressure sensor may only be repaired by the manufacturer.

19.2 Spare parts and repair



NOTE

Keep an identical replacement sensor ready for use in systems that are essential for operation.

Permitted installation or replacement by trained specialist personnel:

Cover and display of the operating unit.

To ensure measurement accuracy and operational safety, all other repairs may only be performed by the manufacturer.

20 Disassembly

- Observe the safety instructions.
- Disassembly is only permitted by trained specialist personnel.

For removal of the pressure sensor → chapter 22.

21 APPENDIX

21.1 Modbus-RTU settings (2001...2005)

Modbus register	Register address	No. of bytes	Data type	Description	Default setting	Read write	Unit/comment
2001	2000	2	UInt16	Modbus ID	1	R/W	Modbus ID 1... 247
2002	2001	2	UInt16	Baud rate	4	R/W	0 = 1200 1 = 2400 2 = 4800 3 = 9600 4 = 19200 5 = 38400 6 = 115200
2003	2002	2	UInt16	Parity	1	R/W	0 = none 1 = even 2 = odd
2004	2003	2	UInt16	Number of stop bits		R/W	0 = 1 stop bit 1 = 2 stop bit
2005	2004	2	UInt16	Word order	0xABCD	R/W	0xABCD = Big Endian 0xCDAB = Middle Endian

21.2 Values Register PTS 500

Modbus Register	Register Address	No. of Byte	Data Type	Description	Read / Write	Comment
1001	1000	4	Float	Temperature	R	[°C]
1003	1002	4	Float	Temperature	R	[°F]
1005	1004	4	Float	Pressure	R	[hPa, mBar]
1007	1006	4	Float	Pressure	R	[bar]
1009	1008	4	Float	Pressure	R	[psi]

21.3 Index Units

Index	Unit	Index	Unit	Index	Unit	Index	Unit	Index	Unit
1	°C	21	Nltr/min	41	V	61	kVAr	65	W
2	°F	22	Nltr/s	42	μV	62	-	81	g/s
3	%RH	23	SCFM	43	kV	63	€	82	g/min
4	°Ctd	24	m ³	44	mA	64	cts/m ³	83	m
5	°Ftd	25	ltr	45	A	65	W	84	ft
6	mg/kg	26	cf	46	kg/s	66	Wh	85	min.
7	mg/m ³	27	Nm ³	47	kg	67	h	86	ms
8	g/kg	28	Nltr	48	AVm ³ /h	68	dB		
9	g/m ³	29	SCF	49	AVl/h	69	mm		
10	m/s	30	ppm	50	AVkg/h	70	inch		
11	fpm	31	°CtdR	51	AVcf/h	71	ltr/h		
12	Nm/s	32	°FtdR	52	kg/h	72	Nltr/h		
13	SFPM	33	Pa	53	kg/min	73	lb/h		
14	m ³ /h	34	hPa	54	Ohm	74	lb/min		
15	m ³ /min	35	kPa	55	Hz	75	lb/s		
16	ltr/min	36	MPa	56	%	76	t/h		
17	ltr/min	37	mbar	57	kW	77	t		
18	ltr/s	38	bar	58	kWh	78	lb		
19	cfm	39	psi	59	PCS	79	SCFH		
20	Nm ³ /h	40	mV	60	kVA	80	cfh		

