

User manual ITFT1

Multifunction measuring input:

Direct voltage, direct current, Pt100, Pt1000, thermocouple, pulse signals for frequency measuring and rotational speed measuring or counter



Technical features:

- indication of measuring value from -1999...9999 digits
- digit height approx. 15 mm
- selectable colour for measuring value and background: red, green, white, black or orange
- minimal installation depth: 25 mm without plug-in terminal, with transformer 42 mm
- display panel 2,4", 320x240 Pixel
- indication of metering point and signal identification
- adjustable signs for physical dimension
- min/max-value recording
- 9 adjustable supporting points
- display flashing at threshold value exceedance / undercut
- Tara function
- programming interlock via access code
- protection class IP65 at the front side
- pluggable screw terminal
- 2 switching points (changer)
- optional: RS485 interface with Modbus protocol
- accessories: PC-based configuration kit PM-TOOL with CD and USB-adapter

Contents

1. Description of the device	3
2. Assembly	3
3. Electrical connection and connection examples	4
3.1. Terminal assignment	4
3.2. Connection examples	4
3.2.1. Voltage / Current	4
3.2.2. Pt100 / Pt1000 / Thermocouple	5
3.2.3. Frequency / Rotational speed	6
3.2.4. Counter upwards/downwards	7
3.2.5. RS485 interface	7
4. Description of function and operation	8
4.1. Operating and display elements	8
4.2. Adjustment of device parameters, numerical values and text	9
5. Adjustment of the device	9
5.1. Power-on	9
6. Parameterization	10
6.1. Selection of measuring signal, Input type	10
6.1.1. Volt / Ampere	11
Select input signal, Input range	
Setting of final and initial value, End value , Start value , Analog end , Analog start	
Setting of decimal point, Decimal dot	
Physical variable (approx. 3-digit), Dimension	
Zero point steadying of the input signal, Value offset (TARA)	
Input of supporting points for the linearisation of the measuring signal, Setpoint num.	
6.1.2. Pt100(0)	12
Select sensor, Sensor type	
Temperature indication in °C/°F, Scale unit	
Impedance matching, Adjustment	
6.1.3. Thermocouple	13
6.1.4. Pulse measurement	14
6.1.4.1. Frequency measurement, Frequency	14
Triggering pulse signal, Input signal	
Frequency range, Input range	
Filter, Filter	
Setting the final value / initial value, End/Start value , Freq. end/start	
Setting the decimal point, Decimal dot	
Physical variable (max. 3-digit), Dimension	
Zero point steadying of the input signal, Value offset	
Input of supporting points for the linearisation of the measuring signal, Setpoint num.	
6.1.4.2. Rotational speed, Rotary	16
Triggering pulse signal, Input signal	
Filter, Filter	
Pulse per turn, Puls/Turn	
Time base, Time base	
Setting of decimal point, Decimal dot	
Physical variable (max. 3-digit), Dimension	
6.1.4.3. Counter upwards/downwards, Count up, Count down	17
Triggering pulse signal, Input signal	
Counter base / input signal, Count base	
Edge, Active edge	
Prescaler, Prescaler	
Filter, Filter	

Contents

Final display value and final pulse value, End value, End count	
Reset, Reset	
Setting the decimal points, Decimal dot	
Physical variable (max. 3-digit), Dimension	
6.2. Alarm parameters A1 to A8	18
Threshold value behaviour, A1 function	
Signalling at threshold value failure, A1 fault	
Switching relay, A1 relay sel.	
Setting the switching threshold, A1 limit	
Setting the hysteresis, A1 Hyster.	
Delayed release, A1 off delay	
On-delay, A1 on delay	
Display flashing at threshold value off-limit condition, A1 flashing	
Indication of the active alarm, A1 signal.type	
Colour change at off-limit condition, A1 DISP.COLOR	
Start alarm menu, To Al. Menu	
6.3. General device parameters / RS485 (Modbus) / safety parameters	21
Setting the display time, Display time	
Setting the measuring time, Measur. Time	
Setting the moving average, Moving aver.	
Overflow / underflow behaviour, Overrange	
Indication of initial/final value in the display, Min value, Max value	
Assignment of functions to the navigation keys, Dir. Keys	
Tara function, 4th key	
Zeropoint suppression, Zeropoint sup.	
Arithmetic functions: reciprocal value, square root and squaring, Arithmetic	
Device address, Modbus adDr.	
Modbus protocol, Modbus mode	
Timeout error, Modbus Timeout	
Transfer of display value, RENOTE CONTR.	
Assignment of a user code to block certain parameters, USER CODE	
Assignment of an individual numerical code for enabling the parameterization, Admin code	
Defines the parameters accessible to the user, USER LEVEL	
Access mode of user menu, USER ACCESS	
Internal serial number, assigned by calibration, Serial number	
6.4. Display parameters	25
Defines the indicated signal name, maximum 15 digits, Signal name	
Defines the indicated area name, maximum 7 digits, Area name	
Brightness of the background light, Brightness	
Colour scheme of the measurand, Displ. Scheme	
Background colour of the measurand, Value f.color	
Font colour of the measurand, Value b.color	
Font colour of the signal name at active alarm, Sign.Al.color	
6.5 Activation / Deactivation of the programming interlock, RUN	25
7. RS485 – Modbus protocol	26
8. Reset to default values	30
Reset of the parameters to delivery state.	
9. Technical data	31
10. Safety advices	34
11. Error elimination	35

1. Description of the device

With the digital display **ITFT1** a wide variety of sensors can be operated and the corresponding physical values are displayed. If temperatures shall be measured via Pt100, Pt1000 or thermocouple, the temperature will be displayed in °C or °F (selectable). For measuring inputs, such as current/voltage, frequency or counter, the scaling and indication can be freely selected in the display range from -1999 to 9999. The device has two switching points which support different operating modes. It can be monitored either via a threshold value with hysteresis or a window contact with alarm range. The switching state of the relay is visualized. Operation or parameterization is carried out via four front keys, optionally the display can also be configured and queried via an RS485 interface or an adapter in conjunction with a software tool.

2. Assembly

Before assembly, please read the *Safety advices* on page 34 and keep this user manual for future reference.

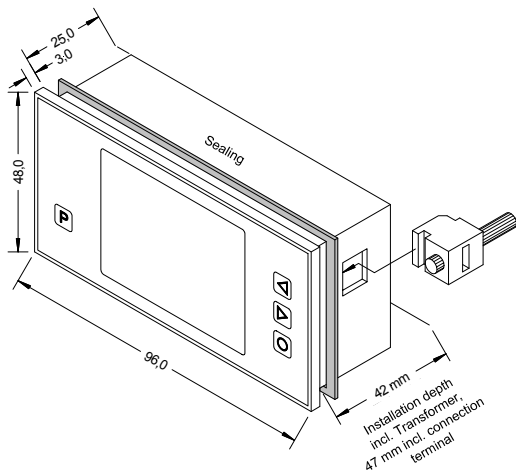

1. After removing the fixing elements, insert the device.
2. Check the seal to make sure it fits securely.
3. Click the fixing elements back into place and tighten the clamping screws by hand. Then use a screwdriver to tighten them another half a turn.

CAUTION! The torque should not exceed 0.1 Nm!

3. Electrical connection

3.1. Terminal assignment

Type ITFT1-11U.000X.X72A

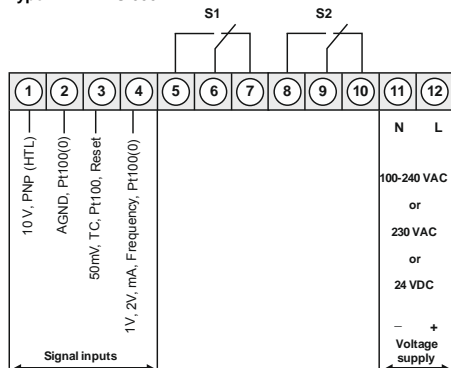

3.2. Connection examples

Below please find some connection examples, which demonstrate some practical applications:

3.2.1. Current / Voltage

2-wire sensor 4-20 mA

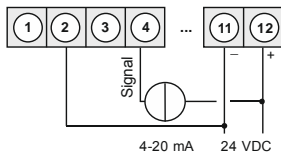

2-wire sensor 4-20 mA with external voltage source

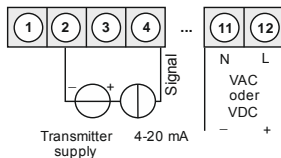

3-wire sensor 0/4-20 mA

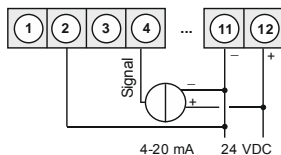

3-wire sensor 0/4-20 mA with external voltage source

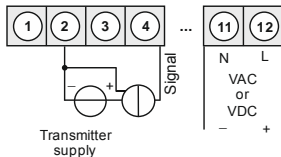

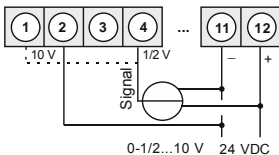
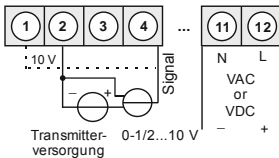
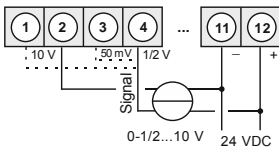
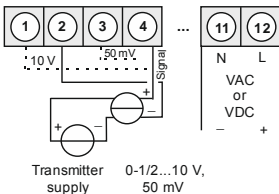
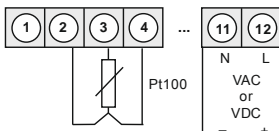
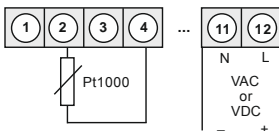
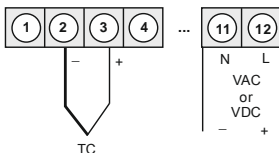
3-wire sensor 0-1/2...10 V**3-wire sensor 0-1/2...10 V
with external voltage source****4-wire sensor 0-1/2...10 V, 50 mV****4-wire sensor 0-1/2...10 V, 50 mV
with external voltage source****3.2.2. Temperature****Pt100 3-wire****Pt1000 2-wire****Thermocouple**

3.2.3. Frequency / Rotational speed

Sensor with TTL output

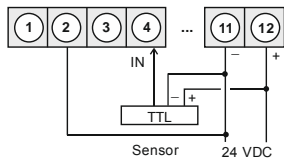

Sensor with ext. voltage source and TTL-output

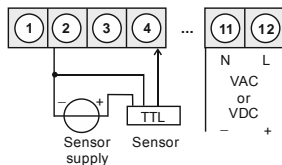

Sensor with PNP-output

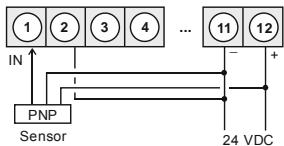

Sensor with ext. voltage source and PNP-output

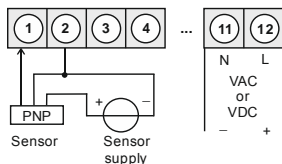

Sensor with NPN-output

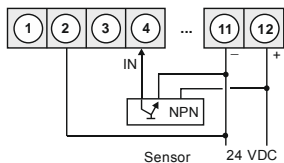

Sensor with ext. voltage source and NPN-output

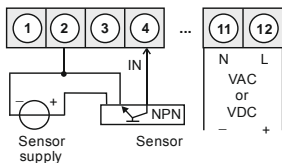

Sensor with NPN-output and required external resistance

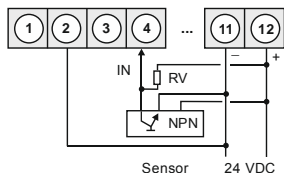

Sensor with ext. voltage source, NPN-output and required ext. resistance

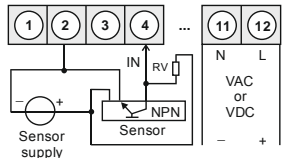

Sensor with PNP-output and external resistance circuit

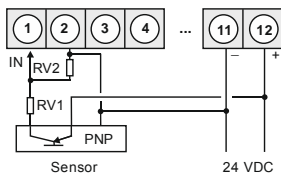

Sensor with external supply, PNP-output and external resistance circuit

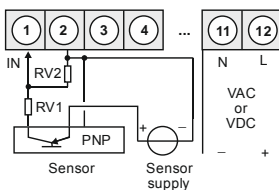

3.2.4. Counter – upwards/downwards

When used as a counter, use the connection examples for frequency / speed and the reset input below.

Manual reset with external feeler

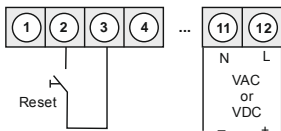

3.2.5. RS485 – Interface (Modbus protocol)

Option (relay 1 and 2 are not applicable):

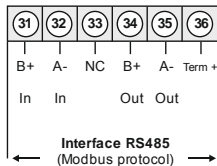

4. Description of function and operation

4.1. Operating and display elements

The indicator is equipped with 4 keys, with which the device can be adjusted and deposited functions can be called up during operation. Parameters, that are adjustable or changeable, will be displayed inverse. Adjustments that were made in the parameter level will be confirmed with **[P]** (short/long) and thus saved. In configuration mode, the name of the parameter appears in the upper window and the current adjustment in the middle of the window. The indicator saves all adjustments automatically (except digit and string sequences, like e.g. area name, end value) and changes into operation mode, if no further key operation takes place within 25 seconds. The two navigation keys **[◀]** & **[▶]** can be used to switch between the different parameters. The configuration mode can be interrupted with the **[O]**-key and a taring can be triggered in operating mode (depends on the selected input).

Key symbol	Function in operation mode	Function during parameterisation
Program Key [P]	Change into parameterisation with program key [P] > 1s.	<ul style="list-style-type: none"> • Change to a lower parameter level or to the desposited value = short <1s [P]. • Value transfer for text paramaters = short <1s [P]. • Position change with digit parameters / string sequences (e.g. End value) = short <1s [P]. • Value transfer at digit parameters / string sequences = long [P] >1s.
Minus key [◀]	Depending on the set key function, the minimum value can be called up or a lower limit value can be changed with the minus key [◀] .	<ul style="list-style-type: none"> • Change between parameters and changing of parameters in the value level.
Plus key [▶]	Depending on the set key function, the maximum value can be called up or an upper limit value can be changed with the plus key [▶] .	<ul style="list-style-type: none"> • Change between parameters and changing of parameters in the value level.
Zero key [O]	Triggering e.g. Tara (Value offset)	<ul style="list-style-type: none"> • Cancellation of the configuration / change menu level (back)

A switched-on relay or an activated switching point is visually reported in the display via a colour change of the background. A display overflow/underflow is displayed via 4 arrows „↑↑↑↑“ respectively „↓↓↓↓“.

4.2. Adjustment of device parameters, numerical values and text

[P] short = <1s

[P] long = >1s

Device parameter, e.g. selection of the input signal

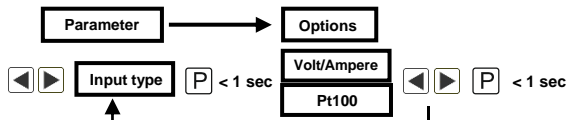

Numerical values, e.g. end value of measuring range

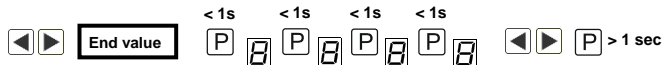

Numerical values are adjusted from the largest to the smallest digit with [◀] [▶] and confirmed digit per digit by briefly pressing the [P]-key. A minus sign can only be parameterized on the most significant digit. After the last digit, the input changes back to the most significant position. A transfer takes place by a long press on the [P]-key. Here, an area monitoring takes place and if necessary a correction option.

Text, e.g. area name

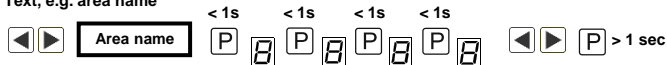

Texts are transferred by a long press on the [P]-key. Only the text to the left of the current cursor position is taken over, all still visible letters and numbers as from the current cursor position are removed. A text length of maximum 15 characters is available. Special characters and lowercase letters are selected by long pressing of the directional keys.

5. Adjustment of the device

5.1. Power-on

After completing the installation, you can put the device into operation by applying the supply voltage. First check all electrical connections again for their correct connection.

Starting sequence

During starting sequence, the device type and software version are displayed for 3 seconds. After the starting sequence follows the change into the operating or display mode.

6. Parameterization

6.1. Selection of input signal: Input type

During the adjustment of the type, an allocation of the input version takes place. Choose between the 7 input types: voltage/current, Pt100(0), thermocouple, frequency, rotary, count up and count down.

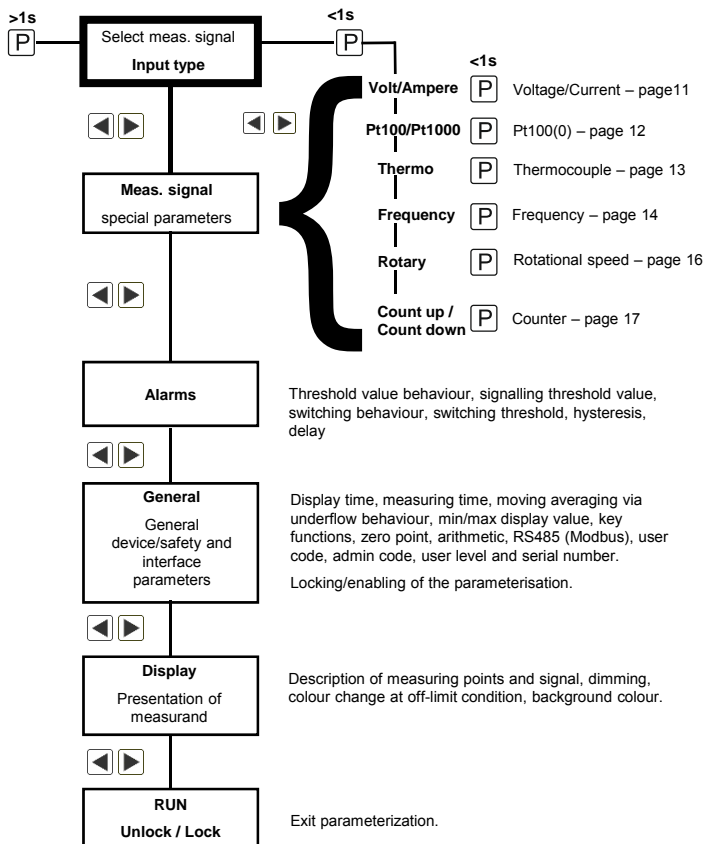

6.1.1. Device parameter for the allocation of voltage/current signals: Volt/Ampere

Signal input: 0...10 V, 0...2 V, 0...1 V, 0...50 mV, 0/4...20 mA

With the measuring inputs voltage/current, it is possible to carry out a calibration directly on the measuring section, in addition to the preset input signals. For this, select **Sen.V** or **Sens.mA** as input type.

If the parameter **Sens.Calib** (calibration) is confirmed with **Yes**, the alignment is made over the measuring path and the analog input value is transferred. If **no** (no calibration) is selected, the previously set display value is taken over.

Parameter	Menu item up to/or		Default
Input type	Volt/Ampere		
Input range	0...10 V	0...2 V	0...10 V
	0...1 V	0...50 mV	
	0...20 mA	4...20 mA	
	Sens V (0...10 V input)	Sens mA (0...20 mA input)	
End value	-1999	9999	1000
Start value	-1999	9999	0000
Decimal dot	0	0.000	0
Dimension	AAAAAAA	<u>ZZZZZZZ</u>	
Analog end	-19.99V	99.99V	10,00V
Analog start	-19.99V	99.99V	0,00V
Value offset	-1999	9999	0
Setpoint num.	0	9	0
Display SP#1	-1999	9999	0100
Analog SP#1	-19.99V	99.99V	01.00V
Display SP#2	-1999	9999	0100
Analog SP#2	-19.99V	99.99V	01.00V
Display SP#3	-1999	9999	0100
Analog SP#3	-19.99V	99.99V	01.00V
Display SP#4	-1999	9999	0100
Analog SP#4	-19.99V	99.99V	01.00V
Display SP#5	-1999	9999	0100
Analog SP#5	-19.99V	99.99V	01.00V
Display SP#6	-1999	9999	0100
Analog SP#6	-19.99V	99.99V	01.00V

Parameter	Menu item up to/or		Default
Display SP#7	-1999	9999	0100
Analog SP#7	-19.99V	99.99V	01.00V
Display SP#8	-1999	9999	0100
Analog SP#8	-19.99V	99.99V	01.00V
Display SP#9	-1999	+9999	0100
Analog SP#9	-19.99V	+99.99V	01.00V

Help text in ticker for parameterization:

Parameter	Menu item up to/or
Input type	Selects the measuring type.
Input range	Select the desired measuring range.
End value	Set the value for the chosen analog end value.
Start value	Set the value for the chosen analog start value.
Decimal dot	Select the position of the shown decimal point in the display.
Dimension	Defines the dimension of the measuring range.
Analog end	Defines the analog end value of the selected measuring range.
Analog start	Defines the analog start value of the selected measuring range.
Value offset	Select the optional offset for the linearization.
Setpoint num.	Select the number of additional setpoints.
Display SP#x	Set the display value for the following analog signal value.
Analog SP#x	Set the analog signal value for the previous display value.

6.1.2. Device parameter for the allocation of Pt100/Pt1000

Signal input: Resistance thermometer Pt100/Pt1000

Parameter	Menu item up to/or		Default
Input type	Pt100(0)		
Sensor type	Pt100 (200°C)	Pt100 (850°C)	Pt100 (200°C)
	Pt1000 (850°C)		
Scale unit	°C	°F	°C
Adjustment	-19.9°C	19.9°C	00.0°C
	-35.9°F	35.9°F	00.0°F

For the Pt100-3-wire signal recording, a distinction is made between Pt100 (200.0°C) for -50... 200°C and Pt100 (850°C) with -200... 850°C measuring range. In the first case, an additional decimal place is displayed. With the Pt1000-2-wire signal recording, the maximum measuring range of -200...850°C is directly covered by the input and the temperature is displayed without decimal place. By default, the Pt100 (0) measurement is displayed with the dimension °C or °F. Other settings are not provided for this measurement.

Help text in ticker for parameterization:

Parameter	Menu item up to/or
Input type	Select the measuring type.
Sensor type	Select the connection type and resolution of the Pt100(0) temperature sensor.
Scale unit	Select the scale unit for the displayed temperature.
Adjustment	Set the measurement offset in °C/°F.

6.1.3. Device parameters for the allocation of Thermocouples: Thermo

Signal input thermocouple types: L, J, K, B, S, N, E, T, R

Parameter	Menu item up to/or				Default
Input type	Thermo				
Sensor type	Type L	Type J	Type K	Type B	Type K
	Type S	Type N	Type E	Type T	
	Type R				
Scale unit	°C		°F		°C
Adjustment	-19.9°C		19.9°C		00.0°C
	-35.9°F		35.9°F		00.0°F

For thermocouples, the dimension °C or °F is adopted by default for the indication of measured values. An additional unit is not provided.

Help text in ticker for parameterization:

Parameter	Menu item up to/or
Input type	Select the measuring type.
Sensor type	Select the type of the thermocouple.
Scale unit	Select the scale unit for the displayed temperature.
Adjustment	Set the measurement offset in °C/°F.

6.1.4 Pulse measurement

6.1.4.1 Device parameter for the allocation of frequency measurement 0-9999 Hz: frequency

Signal input: TTL, NPN, PNP, Namur

Parameter	Menu item up to/or		Default
Input type	Frequency		
Input signal	TTL	NPN	PNP
	PNP	NAMUR	
Input range	9.999Hz	99.99Hz	9999Hz
	999.9Hz	9999Hz	
Filter	2Hz	5Hz	No
	10Hz	20Hz	
	50Hz	100Hz	
	200Hz	500Hz	
	No		
End value	-1999	9999	1000
Start value	-1999	9999	0000
Decimal dot	0	0.000	0
Dimension	AAAAAAA	<u>ZZZZZZZ</u>	
Freq. end	0000Hz	9999Hz	9999Hz
Freq. start	0000Hz	9999Hz	0000Hz
Value offset	-1999	9999	0000
Setpoint num.	0	9	0
Display SP#1	-1999	9999	
Freq. SP#1	0000Hz	9999 Hz	
Display SP#2	-1999	9999	
Freq. SP#2	0000Hz	9999 Hz	
Display SP#3	-1999	9999	
Freq. SP#3	0000Hz	9999 Hz	
Display SP#4	-1999	9999	
Freq. SP#4	0000Hz	9999 Hz	
Display SP#5	-1999	9999	
Freq. SP#5	0000Hz	9999 Hz	
Display SP#6	-1999	9999	
Freq. SP#6	0000Hz	9999 Hz	

Parameter	Menu item up to/or		Default
Display SP#7	-1999	9999	
Freq. SP#7	0000Hz	9999 Hz	
Display SP#8	-1999	9999	
Freq. SP#8	0000Hz	9999 Hz	
Display SP#9	-1999	9999	
Freq. SP#9	0000Hz	9999 Hz	

Help text in ticker for parameterization:

Parameter	Menu item up to/or
Input type	Select the measuring type.
Input signal	Select the type of input signal.
Input range	Select the required frequency range.
Filter	Select an additional frequency filter to reduce the recognition of faulty pulses.
End value	Set the display value for the higher frequency.
Start value	Set the display value for the lower frequency.
Decimal dot	Select the position of the shown decimal point in the display.
Dimension	Defines the dimension of the measuring range.
Freq. end	Define the frequency end value for the given display end value.
Freq. start	Define the frequency start value for the given display start value.
Value offset	Set the optional offset of the display value.
Setpoint num.	Select the number of additional setpoints.
Display SP#x	Set the display value for the following frequency value.
Freq. SP#1	Set the frequency signal value for the previous display value.

6.1.4.2 Device parameter for the allocation for the rotational speed measurement: Rotary

Signal input: TTL, NPN, PNP, NAMUR

Parameter	Menu item up to/or		Default
Input type	Rotary		
Input signal	TTL	NPN	PNP
	PNP	NAMUR	
Filter	2Hz	5Hz	No
	10Hz	20Hz	
	50Hz	100Hz	
	200Hz	500Hz	
	No		
Pulse/turn	0001	9999	0001
Time base	Seconds	Minutes	Minutes
	Hour		
Decimal dot	0	0.000	0
Dimension	AAAAAAA	ZZZZZZZ	

The rotational speed setting represents a simplified frequency measurement, only the essential parameters are listed.

Help text in ticker for parameterization:

Parameter	Menu item up to/or:
Input type	Select the measuring type.
Input signal	Select the type of input signal.
Filter	Select an additional frequency filter to reduce the recognition of faulty pulses.
Pulse/turn	Select the resolution/counts of pulses per turn.
Time base	Select the time base to the shaft speed.
Decimal dot	Select the position of the shown decimal point in the display.
Dimension	Defines the dimension of the measuring range.

6.1.4.3 Device parameter for the allocation for pulse counter: Count up, Count down

Signal input: TTL, NPN, PNP, NAMUR

Parameter	Menu item up to/or		Default
Input type	Count up	Count down	
Input signal	TTL	NPN	PNP
	PNP	NAMUR	
Count base	Pulses	Seconds	Pulses
	Minutes		
Active edge	Positive	Negative	Positive
Prescaler	0001	9999	0001
Filter	2Hz	5Hz	No
	10Hz	20Hz	
	50Hz	100Hz	
	200Hz	500Hz	
	No		
End value	-1999	9999	1000
End count	0001	9999	1000
Reset	0000	9999	0
Decimal dot	0	0.000	0
Dimension	AAAAAAA	ZZZZZZZ	

Reset:

With the setting "Reset = 0", the initial value is reset for a reset contact. If the value is not equal to zero, the display value is changed by the number of entered pulses. The change in value occurs in the opposite direction to the preset running direction.

Help text in ticker for parameterization:

Parameter	Menu item up to/or
Input type	Select the measuring type.
Input signal	Select the type of input signal.
Count base	Select the source of counting.
Active edge	Select the active edge.
Prescaler	The prescaler is able to be increased to work with higher frequency signals.
Filter	Select an additional frequency filter to reduce the recognition of faulty pulses.
End value	Define the display value for reaching the end count.
End count	Define the counting value for the end value.
Reset	Select the reset value and behaviour.
Decimal dot	Select the position of the shown decimal point in the display.
Dimension	Defines the dimension of the measuring range.

6.2. Alarm parameter A1

Parameter	Menu item up to/or		Default
A1 function	Off	On	Off
	Exceed limit	Undercut limit	
	In the range	Out of range	
A1 fault	No change	Off	No change
	On		
A1 relay sel.	No relay	Relay 1	Relay 1
	Relay 2		
A1 limit	-1999	9999	0100
A1 upper lim.	-1999	9999	0150
A1 lower lim.	-1999	9999	0100
A1 hyster.	0000	9999	0000
A1 off delay	0s	100s	0s
A1 on delay	0s	100s	0s
A1 flashing	Deactive	Activated	Deactive
A1 signal type	Background	Font	Font

Parameter	Menu item up to/or:		Default
A1 displ. color	Deactive	Green	Deactive
	Red	Orange	

The same applies to alarms A2 to A8!

Help text in ticker for parameterization:

Parameter	Menu item up to/or:
A1 function	Select the limit behaviour. The other parameter are not displayed by by „off“.
A1 fault	Select the limit fault behaviour. On an internal error, the alert goes to the selected state.
A1 relay sel.	Select the relay to be switched.
A1 limit	Define the limit value for the choosed function.
A1 upper lim.	Define the upper limit for the range control.
A1 lower lim.	Define the lower limit for the range control.
A1 hyster.	Define the hysteresis for the limit value.
A1 off delay	Define the delay time to off state for the alarm.
A1 on delay	Define the delay time to on state for the alarm.
A1 flashing	Enables the flashing mode, which will be activated by alarm.
A1 signal type	Determines the kind of signalling for an active alarm.
A1 disp.color	Select the display color, which will be activated by alarm.

The same applies to alarms A2 to A8!

A1 Function: Threshold value behaviour

With the principle of operation it is possible to switch between different operating types of the alarms. If **A1 function = Off** is selected, the associated alarm parameters are not displayed.

Off	The alarm has no function and associated parameters are not displayed. (Default state).
On	The alarm is switched on in measuring mode.
Exceed limit	Activate when threshold value is exceeded.
Undercut limit	Activate when threshold value is undercut.
In the range	Switch in the specified range.
Out of range	Switch outside the specified range.

A1 fault: Signalling at threshold value failure

If a device checksum is incorrect or the display range is violated, you can preset the behavior of the alarms.

On	The selected alarm behavior is activated.
Off	The alarm behaves reversely. The malfunction overwrites the actual threshold value function when an error has occurred.
No change	Here, an error has no defined effects.

A1 relay sel.:

Here, the switching relay is selected. Available are „**Relay 1**“, „**Relay 2**“ or „**no Relay**“.

A1 limit: Switching threshold

Via this parameter, the switching threshold is specified, from which an alarm responds, or is activated/deactivated. For the window function of a switching point, this parameter is not requested.

A1 hyster: Hysteresis

The hysteresis defines a difference to the threshold value by which an alarm descends delayed. For the window function of a switching point, this parameter is not requested.

A1 upper lim: Upper threshold value**A1 lower lim:** Lower threshold value

For the range functions **A1 function = in the range** or **Out of range**, this value between -1999...+9999 defines the upper or lower limit of the window function. For other operating principles, this parameter is suppressed.

A1 off delay: Delayed release.

Here, you can specify a delayed switch-off of 0-100 seconds for the threshold values. The internal time counter is not stored permanently and reset by a device start.

A1 on delay: On-delay.

Here, you can specify a delayed switch-on of 0-100 seconds for the threshold values. The internal time counter is not stored permanently and reset by a device start.

A1 flashing: Flashing on alarm

Here, you can choose the flashing of the current display or the background colour.

A1 signal.type: Signalling on alarm.

Indication is selectable via background colour or font colour.

A1 disp.color: Display colour on alarm.

Specifies the display colour on active alarm.

6.3. General: General device parameters / safety parameters

Parameter	Menu item uo to/or		Default
Display time	0.1s	2.0s	1.0s
Measur. Time	0.1s	2.0s	1.0s
Overrange	Deactive	ADC	ADC
	Full range	5% range	
	10% range		
Moving aver.	01	20	01
Min. value	-1999	9999	-1999
Max. value	-1999	9999	9999
Dir. Keys	No function	Maximal request	No function
	Set limits		
4th Key	No function	Taring	No function
Zeropoint sup.	0	99	0
Arithmetic	no	Square Root	no
	Square	Reciprocal	
Modbus Addr. 1	1	250	1
Modbus Mode	ASCII	RTU	ASCII
Modbus Timeout	0 s	100 s	0 s
Remote Contr.	Off	On	Off
User code	0	9999	0000
Admin code	0	9999	1234
User level	1	7	7
User access	Unlock	Lock	Unlock
Serial number			

Help text in ticker for parameterization:

Parameter	Menu item up to/or
Display time	Define the display update time.
Measur. Time	Define the measurement time.
Moving ave.	Define the number of measuring values for the moving averaging.
Min. value	Define the lower display limit.
Max. value	Define the higher display limit.
Dir. Keys	Select the special function of the direction keys.
4th Key	Select the special function of the 4th key.
Zero point sup.	Defines a range around the zero point, in which the measurand is set to zero.
Arithmetic	Select an arithmetic conversion function for the process value.
Modbus Addr.	Set the device address for the communication with a MODBUS Master.
Modbus Mode	Select the MODBUS communication mode.
Modbus Timeout	Define the value of received timeout. If a timeout occurred, an error signal is generated, which can be monitored by an alarm.
Remote contr.	The enabled remote control will let the MODBUS master control display, alarms and relays.
User code	Select a code, to lock the user parameter settings.
Admin code	Select a code, to lock the administrator parameter settings.
User level	Select the user level for restricted setting options.
User access	Select the access mode of the user menu.
Serial number	Displays the serial number of the device.

Measur.time and Moving aver.:

The menu items **Measur.time** and **Moving aver.** cannot be selected for all input types. They are missing at the temperature inputs (Pt100(0)/Thermo) and pulse inputs (Count up/Count down) and are defined as follows:

Pt100(0)/Thermo: Measur.time: 1 sec, Moving aver.: 10

Count up/Count down: Measur. time: 100 ms, Moving aver.: 0

Display time:

Update rate of the digital display in seconds. The currently valid measurand is displayed.

Measur. time:

Over the set measuring time, the display carries out an averaging of the measuring input, whereby at higher measuring times, a higher resolution and measuring accuracy is achieved. Thus the value will be steady. Especially with a very short measuring time of 0.1 sec, higher or more frequent jumps in the digital display may occur.

Overrange:

Deposit of key functions. If you select **Maximum request**, the min/max-memory is cleared by simultaneously pressing the direction keys. With **Set limit**, threshold values can be selected using the arrow keys and changed or accepted by pressing the **[P]**-key. With **no function**, no functions are deposited.

Parameter	Menu item up to/or:
Deactive	There is no additional range check here. If the display area is left, the display simply remains at the lowest value or the highest value.
ADC	If the min/max value " I1 Min. Value " / " I1 Max. Value " is exceeded or undercut, overflow or underflow is indicated.
Full range	The measuring signal must be within the preset measuring range " I1 End " / " I1 Start ", so that no overflow is detected.
5% range	The measuring signal is monitored for $\pm 5\%$ of the set measuring range.
10% range	The measuring signal is monitored for $\pm 10\%$ of the set measuring range.

Moving average:

Additional averaging of the last measured values. This will steady the display.

Min. value:

This feature allows you to define the display underflow to a specific value. The exception is input type **4-20 mA**, which already indicates an underflow at signal <1 mA, thus indicating a sensor failure.

Max. value:

This feature allows the device overflow to be defined to a preset value.

Dir. Keys:

Assignment/deposit of key functions in operating mode. Here, you can use the navigation keys [**◀**] [**▶**] to query and to reset the minimum/maximum value by simultaneously pressing (<1 sec) the two keys. If one selects the threshold value correction **set limits**, one can change the values of the threshold values during operation without hindering the operating sequence. If **no** is selected, the navigation buttons have no function in the operation mode.

4th key (Tara function):

For the operating mode, a special function for the input types volt/ampere and frequency can be deposited on the [**O**]-key. This function is triggered by pressing the key <1 sec. **Taring** tares the display to zero and stores it as an offset. The display acknowledges the correct taring with showing "- - -" in the display. **Attention!** The value is lost when the device is restarted. If **No function** is selected, the [**O**]-key has no function in operating mode.

Zeropoint sup.:

With the zero point steadying, it is possible to force the display to display a value of "0" for very small input signals. Here, a numerical value is set, up to the amount of this value the display indicates a "0". This function can be used to e.g. force a temperature drift of the measuring path around the zero point to "0" in the display during an analog speed measurement. In the same way you suppress negative speeds.

Arithmetic:

This function does not indicate the measured value in the display, but the calculated value. Available are: reciprocal value, square root and squaring.

Calculation types

Reciprocal = Final value/Display value

Square root = $\text{Root}(\text{Display value} \times \text{Final value})$

Square = $(\text{Display value})^2 / \text{Final value}$

Advice: The denominator of fractions should not be 0 because a division by 0 is not possible. It creates an undefined state and the display goes into the overflow.

Modbus Addr.:

The device address can be used to approach the display via the optional bus connection. The Modbus specifications are valid.

Modbus Mode:

Preferably, the Modbus protocol ASCII is used. In addition, the display can be operated in the Modbus protocol RTU, which has a higher data density. However, the latter is more time-critical in terms of communication, since the protocol limits are not detected here with start and stop characters, but with defined times. The PM-TOOL parameter software only supports the ASCII protocol.

Modbus Timeout:

If a value greater than 0 is set, an internal timer is reset to the set value for each communication. If the timer runs onto zero, a timeout error is generated. This leads to an error bit, which can be output via a register or forwarded to an alarm.

Remote contr.:

The display value is taken over via Modbus with the setting **ON**.

User code:

With this code, a limited access to the parameters is possible, depending on the set user level. The user has only access to the shared parameters.

Admin. Code:

This code allows full access to all parameters.

User level:

Defines the parameters accessible to the user:

User level = access to menu	Description	1234567
Alarm X	Threshold value	XXXXXXX
Alarm X	Hysteresis/Threshold value	XXXXXX
Alarm X	All parameters	XXXXX
Measuring input		XXX
General		XXX
Display		XXX

6.4. Display - Parameter

Parameter	Menu item up to/or		Default
Signal name	maximum 15 digits		
Area name	maximum 7 digits		
Brightness	0	9	7
Displ. scheme	Dark	Light	Dark
Value f.color	Deactive	Red	Deactive
	Green	Orange	
	Black	White	
Value b.color	Deactive	Red	Deactive
	Green	Orange	
	Black	White	
Sign.Al.color	Default	Measuring value	Default

Signal name:

Maximum 15 digits are possible. Indication above the measured value.

Area name:

Maximum 7 digits are possible. Indication between the switching state of the relays and the dimension, below the measured value.

Help text in ticker for parameterization:

Parameter	Menu item up to/or:
Signal name	Define the displayed signal name.
Area name	Define the displayed area name.
Brightness	Select the brightness of the background light.
Displ.scheme	Select the color scheme of the display.
Value b.color	Select the background color of the measured value.
Value f.color	Select the font color of the measured value.
Sign. Al.color	Select the behaviour of font color of the signal name, when an alarm is active.

6.5. Activation / Deactivation of the programming interlock, Run

Here, select with [◀] [▶] between deactivated key lock **UNLOC** (factory settings) and activated key lock **LOCK**. By pressing the [P]-key, the device switches automatically into operating mode. If **UNLOC** is selected, the parameterization can be started by pressing the [P]-key in operating mode. If **LOCK** is selected, the user code/release code that was specified under chapter 6.3. *General, general display parameters / safety parameters*, must be adjusted.

7. RS485 – Modbus protocol

The display value sent via Modbus can be steadied by moving averaging. The display always communicates via the Modbus protocol with the PC. This is independent of the fact whether an RS485 interface is available or not. For displays without RS485 interface, the transmission is carried out via the configuration interface.

The byte protocol is determined to:

1 start bit, 8 data bits, 1 stop bit, no parity to a confirmed Baud rate of 9600 Baud.

For devices without an RS485 interface, there is no direct access to the parameters for the Modbus, in this case, only the use of the TTL interface for configuration via the PM-TOOL is provided. These parameters can also be adjusted via the bus.

Modbus-ASCII

Start	Device address	Function	Data	CRC value	End
Sign „:“	2 signs	2 signs	nx 2 signs	2 signs	2 signs „/r/n“

Modbus RTU (Holding time > 4 ms between the frames)

Device address	Function	Data	CRC value
1 Byte	1 Byte	n Bytes	2 Bytes

Supported function codes

0x03	READ HOLDING REGISTER	e.g. measuring values and alarm status
0x04	READ INPUT REGISTER	same function as code 0x03.
0x08	DIAGNOSTIC	device diagnostics
0x10	WRITE MULTIPLE REGISTER	e.g. transfer display value and alarm status to the device

Modbus – Index

Name	Index	Access mode	min/max value data type	Comment	
Device number	0x4400/17408	read/write	UINT16		
Binary value LOW-WORD	0x6100/24832	read	UINT16		
Binary value HIGH-WORD	0x6101/24833	read	UINT16		
Alarm status	0x4520/17696	read/write	UINT18	Bit0...Bit7 equates alarm 1...8	
Measured value HIGH-WORD	0x7001/28673	read/write	-20000...100000 FLOAT	Current scaled measuring value	
Measured value LOW-WORD	0x7000/28672				
Decimal point	0x6002/24578	read/write	0...3 UINT16	(write only in remote contr. mode)	
				Value	Dis- play
				0	0
				1	0.0
				2	0.00
3	0.000				
Signal name (byte 0:1)	0x4600/17920	read/write	CHAR	Signal name	
Signal name (byte 2:3)	0x4601/17921			(Fill unused bytes with zeros!)	
Signal name (byte 4:5)	0x4602/17922			maximum 15 signs	
Signal name (byte 6:7)	0x4603/17923				
Signal name (byte 8:9)	0x4604/17924				

Name	Index	Access mode	min/max value data type	Comment			
Signal name (byte 10:11)	0x4605/17925	read/write	CHAR	Signal name (Fill unused bytes with zeros!) maximum 15 signs			
Signal name (byte 12:13)	0x4606/17926						
Signal name (byte 14:15)	0x4607/17927						
Area name (byte 0:1)	0x4610/17936	read/write	CHAR	Area name (Fill unused bytes with zeros!) maximum 15 signs			
Area name (byte 2:3)	0x4611/17937						
Area name (byte 4:5)	0x4612/17938						
Area name (byte 6:7)	0x4613/17939						
Area name (byte 8:9)	0x4614/17940						
Area name (byte 10:11)	0x4615/17941						
Area name (byte 12:13)	0x4616/17942						
Area name (byte 14:15)	0x4617/17943						
Dimension (byte 0:1)	0x4620/17952				read/write	CHAR	Dimension (Fill unused bytes with zeros!)
Dimension (byte 2:3)	0x4621/17954						
Dimension (byte 4:5)	0x4622/17955						
Dimension (byte 6:7)	0x4623/17956						

Name	Index	Access mode	min/max value data type	Comment	
Display brightness	0x4680/18048	read/write	0...9 UINT16	Value	Function
				0	Minimum brightness
				...	
				9	Maximum Brightness
Relay 1 active	0x4500/17664	read	0/1 UINT16	Value	Function
				0	inactive
				1	active
Relay 2 active	0x4501/17665	read	0/1 UINT16	Value	Function
				0	inactive
				1	active
Output measuring value LOW-WORD	0x6000/24576	read/write	UINT16	Enter measuring value via Remote contr.	
Output measuring value HIGH-WORD	0x6001/24577	read/write			

Measuring value and binary value are designed as 32 bit values and need to be transferred as Word, in 2x 16 bit parts. The byte sequence within the Word is: first HiGH-Byte and then LOW-Byte.

In order to be able to use the particular Modbus functions, the corresponding parameters of the units must be set correctly. Set the **Device Mode** onto **Remote Contr.**, to write the display value directly.

Set the particular **Ax-function** onto **Modbus** for a direct triggering of the alarms via the bus. Each alarm status can be changed or readout via the corresponding bit. Bit0 equates alarm 1...bit 7 equates alarm 8.

8. Reset to default values (factory settings)

In order to put the device into a defined basic state, it is possible to perform a reset to the default values. The following procedure should be used for this:

Switch off the voltage supply of the device. Press **[P]-key** and switch voltage supply again while holding down the **[P]-key**. Press the **[P]-key** until the device answers with **Reset config**.

There are two options available:

YES, the default values are loaded and used for further operation. The display is reset to the delivery state.

NO, error messages that have occurred due to short-term faults in the system can be acknowledged. The device works with the user specific data.

ATTENTION! With "YES" all user-specific data is lost!

9. Technical data

Housing			
Dimensions	96x48x42 mm (BxHxD) with trafo, D = 47 mm with plug-in terminal		
Panel cut-out	92.0 ⁺⁰⁸ x 45.0 ⁺⁰⁶ mm		
Fixing	screw elements for a wall thickness up to 3 mm		
Material	PC Polycarbonate, black, UL94V-0		
Sealing material	EPDM, 65 Shore, black		
Protection class	front side IP65 (Standard), back side IP00		
Weight	approx. 150 g		
Connection	plug-in terminal; wire cross section up to 2.5mm ²		
Display			
Display type	full graphics TFT-display with 320x240 Pixel, font type: Segoe UI		
Digit height	15 mm		
Display measurand	-1999 to 9999		
Background / font colour of measurand	red, green, white, black or orange (selectable)		
Threshold values	Optical display flashing / relay number / colour change		
Signal	Measuring range	Measuring span	Resolution
Voltage	0...10 V Ri > 100 Ohm	0...12 V	14 bit
Voltage	0...2 V Ri 10 kOhm	0...2,2 V	14 bit
Voltage	0...1 V Ri 10 kOhm	0...1.1 V	14 bit
Voltage	0...50 mV Ri 10 kOhm	0...75 mV	
Current	4...20 mA Ri = ~125 Ohm	1...22 mA	
Current	0...20 mA Ri = ~125 Ohm	0...22 mA	
Pt100-3-wire	-50...200°C	-58...392°F	0.1°C / 0.1°F
Pt100-3-wire	-200...850°C	-328...1562°F	1°C / 1°F
Pt1000-2-wire	-200...850°C	-328...1562°F	1°C / 1°F
Thermo K	-270...1350°C	-454...2462°F	1°C / 1°F
Thermo S	-50...1750°C	-328...3182°F	1°C / 1°F
Thermo N	-270...1300°C	-454...2372°F	1°C / 1°F
Thermo J	-170...950°C	-274...1742°F	1°C / 1°F
Thermo T	-270...400°C	-454...752°F	1°C / 1°F
Thermo R	-50...1768°C	-58...3214°F	1°C / 1°F
Thermo B	80...1820°C	176...3308°F	1°C / 1°F

Signal	Measuring range	Measuring span	Resolution	
Thermo E	-270...1000°C	-454...1832°F	1°C / 1°F	
Thermo L	-200...900°C	-328...1652°F	1°C / 1°F	
Frequency	0...10 KHz	0...10 kHz	0.001 Hz ±1	
NPN	0...3 kHz	0...3 kHz	0.001 Hz ±1	
PNP	0...1 kHz	0...1 kHz	0.001 Hz	
Rotational speed	0...9999 1/min	0...9999 1/min	0.001 1/min	
Counter	0...9999 (prescaler up to 1000)			
Pulse input	TTL	HTL/PNP	NPN	Namur
	Low <2 V, High >3 V	Low <6 V, High >8 V	Low <0.8 V, High via resistance	Low <1.5 mA, High >2.5 mA
Reset input	active <0.8 V			
Interface	RS485 Protocol	9600 Baud, no parity, 8 data bit, 1 stopp bit, wire length maximum 1000 m Modbus with ASCII or RTU protocol		
Output	Relay with changeover contact			
	30 VDC / 2 A resistive load Attention! A high switching current leads to a heat development which has an effect on the accuracy of the thermocouple measurement!			
Measuring fault	Standard			
	0.2% of measuring range ± 1 digit			
	Pt100 / Pt1000			
	0.5% of measuring range ± 1 digit			
	Thermocouple			
	0.3% of measuring range ± 1 digit			
Accuracy	Reference junction			
	± 1°C			
	Temperature drift			
	100 ppm / K			
	Measuring time			
	0.1 to 2.0 seconds			
	Measuring rate			
	approx. 1/s with temperature sensor, approx. 100/s with standard signals			
	Measuring principle			
	U/F-conversion			
	Resolution			
	approx. 14 bit at 1 second measuring time			

Power pack	
Supply	100-240 VAC 50/60 Hz, DC $\pm 10\%$, ≤ 6 VA
	230 VAC 50/60 Hz, $\pm 10\%$, ≤ 10 VA
	24 VDC $\pm 10\%$ galvanic isolated, ≤ 3 VA
Memory	
	EEPROM
Data preservation	≥ 100 years at 25°C
Ambient conditions	
Working temperature	-20°C...+50°C without dew
Working temperature	-30°C...+70°C
Weathering resistance	relative humidity 0-85% on years average without dew
EMV	
	EN 61326
CE marking	Conformity according to directive 2014/30/EU.
Safety regulations	According to low voltage directive 2014/35/EU, EN 61010; EN 60664-1.

10. Safety advices

Please read the following safety advices and the assembly chapter 2 before installation and keep it for future reference.

Proper use

The **ITFT1-13**-device is designed for the evaluation and display of sensor signals.



Danger! Careless use or improper operation can result in personal injury and/or damage the equipment.

Control of the device

The panel meters are checked before dispatch and sent out in perfect condition. Should there be any visible damage, we recommend close examination of the packaging. Please inform the supplier immediately of any damage.

Installation

The **ITFT1-13**-device must be installed by a suitably qualified specialist (e.g. with a qualification in industrial electronics).

Notes on installation

- There must be no magnetic or electric fields in the vicinity of the device, e.g. due to transformers, mobile phones or electrostatic discharge.
- **The fuse rating of the supply voltage should not exceed a value of 0.4 A N.B. fuse!**
- Do not install **inductive consumers** (relays, solenoid valves etc.) near the device and **suppress** any interference with the aid of RC spark extinguishing combinations or free-wheeling diodes.
- Keep input, output and supply lines separate from each other and do not lay them parallel with each other. Position "go" and "return lines" next to one another. Where possible use twisted pair. So, the best measuring results can be received.
- Screen off and twist sensor lines. Do not lay current-carrying lines in the vicinity. Connect the **screening on one side** on a suitable potential equaliser (normally signal ground).
- The device is not suitable for installation in areas where there is a risk of explosion.
- Any electrical connection deviating from the connection diagram can endanger human life and/or can destroy the equipment.
- The terminal area of the devices is part of the service. Here electrostatic discharge needs to be avoided. Attention! High voltages can cause dangerous body currents.
- Galvanically isolated potentials within one complex need to be placed on an appropriate point (normally earth or machines ground). So, a lower disturbance sensibility against impacted energy can be reached and dangerous potentials, that can occur on long lines or due to faulty wiring, can be avoided.

11. Error elimination

	Error description	Measures
1.	The unit permanently indicates overflow.	<ul style="list-style-type: none"> The input has a very high measurement, check the measuring circuit. The display range of 9999 respectively the preset measuring range was exceeded, control the supporting points respectively the selected input type and signal range. Not all of the activated supporting points are adjusted. Check if the relevant parameters are set correctly.
2.	The unit permanently shows underflow.	<ul style="list-style-type: none"> The input has a very low measurement, check the measuring circuit. The display range of -1999 respectively the preset measuring range was underrun, check the settings. Not all activated supporting points are parameterized. Check if the relevant parameters are set correctly. Check that the correct input type is selected. Only 4 ... 20 mA displays this error message. Check the wiring for contact or correct connection.
3.	The unit shows HELP in the display.	<ul style="list-style-type: none"> The device has detected an error in the configuration memory, perform a reset to the default values and reconfigure the device according to your application.
4.	Parameter for the parameterization of the input are not available.	<ul style="list-style-type: none"> The programming lock is activated. Enter correct code.
5.	Configuration errors	<ul style="list-style-type: none"> The configuration of the device is secured by a checksum, which is checked at startup or when returning from Settings. If an error is detected in the user settings, a Config error appears in the upper display window and the alarms go into their optional safety state. In this state, it is still possible to carry out a reset to the factory settings. In the input area, Reset settings or Restart system can be selected. At Restart system the device tries to do a re-start. In case of Reset setting the user settings will be set back to the factory settings. If this is also disturbed, System error appears.
6.	The device does not respond as expected.	<ul style="list-style-type: none"> If you are not sure, that the device has already been parameterized before, then restore the delivery state as described in chapter 7.

	Error description	Measures
7.	For thermocouple measurement, there are higher constant measurement deviations.	<ul style="list-style-type: none">• Remove strong sources of heat or cold from the immediate vicinity of the device.• Reduce the switching capacity of the relay switching points to as far as possible below 10 mA, as higher switching currents lead to increased local heating and thus to a greater error in the cold junction measurement.• If the deviations during operation are permanent and constant, the cold junction measurement can be corrected via the offset.

