

# Model IWS12EX with analog output Dust explosion-proof

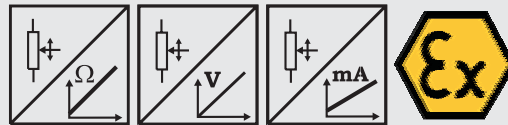

## Sensor for hostile environments

- Protection class IP67
- Measurement ranges:  
0 ... 100 mm to 0 ... 3000 mm
- Analog output
- Dust ex proof, category 3, zone 22
-  II 3D EEx T95°C IP67



Specifications	Outputs	Potentiometer: 1 kΩ Voltage: 0...10 V Current: 4...20 mA, 2 or 3 wire
	Material	Aluminium and stainless steel. Cable: stainless steel
Resolution	Essentially infinite	
Sensing Device	Precision potentiometer	
Connection	Cable output, standard length 1.5 m	
Linearity	Up to ±0.05 % full scale	
Weight (approx.)	≤1500 mm: 1 kg; ≥2000 mm: 1.5 kg	
Operation temperature	-20 to +70 °C	
Conformity of standards		
Explosion-proof	DIN EN 50281:1999, category 3, zone 22	
EMC	DIN EN 61326:2004	
Protection class of housing	DIN EN 60529:2000, IP67	
Shock	DIN EN 60068-2-27:1993, 50 g 11 ms, 100 shocks	
Vibration	DIN EN 60068-2-6:1995, 20 g, 10 Hz ... 2 kHz, 10 cycles	

Order Code IWS12EX	Model Name	IWS12EX	-	-	-	-	-
<b>Analog</b>							
	<b>Measurement Range (in mm)</b>	100 / 125 / 500 / 1000 / 1250 / 1500 / 2000 / 2500 / 3000					
	<b>Outputs (see pages 57 and 58)</b>	R1K = Potentiometer 1 kΩ (other values on request) 10V = with 0 ... 10 V signal conditioner 420A = with 4 ... 20 mA signal conditioner (2 wire) 420T = with 4 ... 20 mA signal conditioner (3 wire)					
	<b>Linearity</b>	L10 = ±0.10 %    option:    L05 = ±0,05 %    L25 = ±0.25 %					
	<b>Connection</b>	KAB1,5M = Cable output, standard length 1.5 m					
	<b>Cable fixing</b>	M4 = M4 cable fixing SB0 = Cable clip					

Order Example: IWS12EX - 2500 - 420T - L10 - KAB1,5M - M4

# Model IWS12EX with analog output Dust explosion-proof

Cable Forces typical at 20 °C	Range	Maximum Pull-out Force	Minimum Pull-in Force
	[mm]	[N]	[N]
	100	5.2	2.8
	125	4.6	2.5
	500	5.9	2.6
	1000	5.5	2.4
	1250	4.8	2.1
	1500	10.4	6.4
	2000	8.1	5.0
	2500	6.7	4.0
	3000	6.2	3.0

## Outline drawing

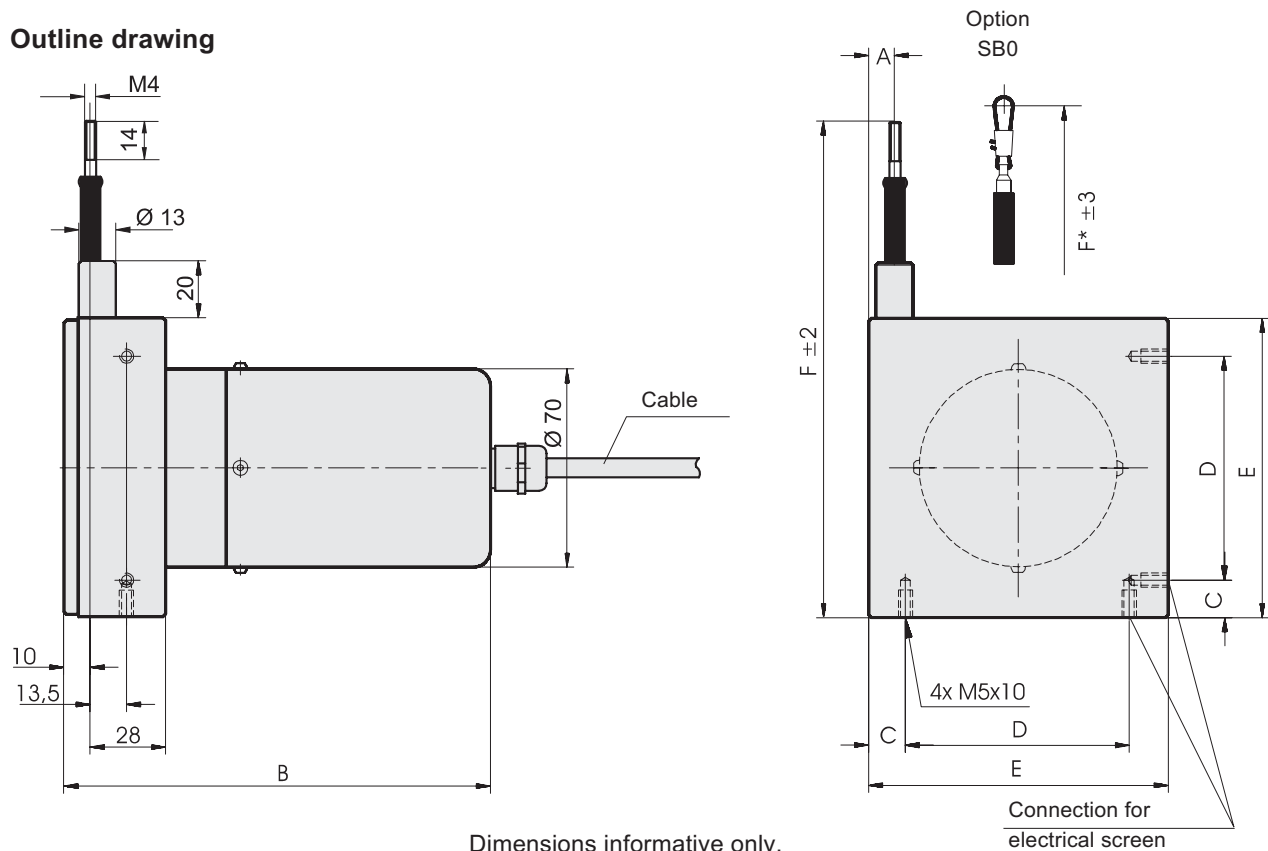

Dimensions informative only.  
For guaranteed dimensions consult factory

Dimensions	Range	A	B	C...E	F (F*)
	[mm]				
	100; 500; 1000	18.5	112		
	125; 1250	15.0	112	C=14, D=43, E=71	141 (149)
	1500	11.0	127		
	2000	22.0	127		
	2500	13.5	127	C=15, D=79, E=109	179 (187)
	3000	9.5	127		

# Output Specifications

## R1K and 10V for IWS position sensors

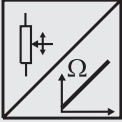
<b>Voltage divider R1K</b> Potentiometer 	Excitation Voltage	32 VDC max. at 1 k $\Omega$ (input power 1 W max.)
	Potentiometer Impedance	1 k $\Omega$ $\pm$ 10%
	Thermal coefficient	$\pm$ 25 x 10 <sup>-6</sup> / °C full scale
	Sensitivity	Depends on measurement range, individual sensitivity of sensor specified on label
	Voltage Divider Utilization Range	Approx. 3% ... 97% of full range
	Operating Temperature	-20 ... +85 °C

### Signal diagram

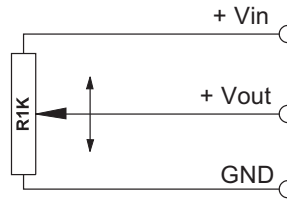

Note: The potentiometer must be connected as a voltage divider. The input impedance of the following processing circuit should be 10 M $\Omega$  min.

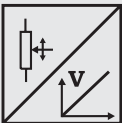
<b>Signal conditioner 10V</b> Voltage output 	Excitation Voltage	+18 ... +27 V DC non stabilized
	Excitation Current	20 mA max.
	Output Voltage	0 ... +10 V DC
	Output Current	2 mA max.
	Output Load	> 5 k $\Omega$
	Stability (Temperature)	$\pm$ 50 x 10 <sup>-6</sup> / °C full scale
	Protection	Reverse polarity, short circuit
	Output Noise	0,5 mV <sub>RMS</sub>
	Operating Temperature	-20 ... +85 °C
	EMC	According to EN 61326:2004

### Signal diagram

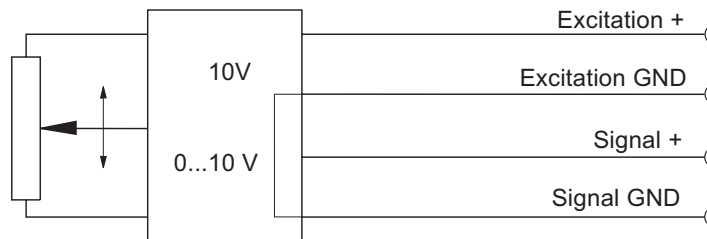

Signal Wiring	Output signals		Cable color	Connector pin no.
	R1K	10V		
	+ Vin	Excitation +	White	1
	GND	Excitation GND	Brown	2
	+ Vout	Signal +	Green	3
		Signal GND	Yellow	4

### Connection

#### Mating Connector

View to solder terminals

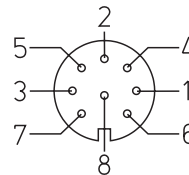

CONN-DIN-8F-W

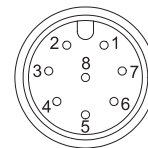

CONN-M12-8F-G

# Output Specifications 420A and 420T for IWS position sensors

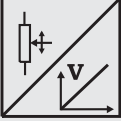
<b>Signal conditioner 420A</b> Current output (2 wire) 	Excitation Voltage	+12 ... 27 VDC non stabilized, measured at the sensor terminals
	Excitation Current	35 mA max.
	Output Current	4 ... 20 mA equivalent to 0 ... 100% range
	Stability (Temperature)	$\pm 100 \times 10^{-6} / ^\circ\text{C}$ full scale
	Protection	Reverse polarity, short circuit
	Output Noise	0.5 mV <sub>RMS</sub>
	Operating Temperature	-20 ... +85 °C
	EMC	According to EN 61326:2004

## Signal Diagram

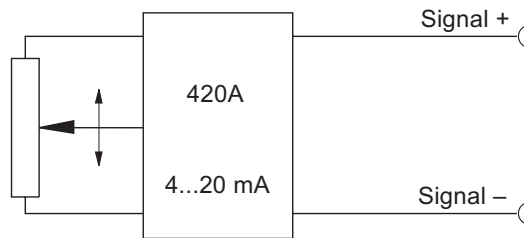

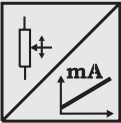
<b>Signal Conditioner 420T</b> Current output (3 wire) 	Excitation Voltage	+18...+27 V DC non stabilized
	Excitation Current	40 mA max.
	Load Resistor	350 Ω max.
	Output Current	4 ... 20 mA equivalent to 0 ... 100% range
	Stability (Temperature)	$\pm 50 \times 10^{-6} / ^\circ\text{C}$ full scale
	Protection	Reverse polarity, short circuit
	Output Noise	0.5 mV <sub>RMS</sub>
	Operating Temperature	-20 ... +85 °C
	EMC	According to EN 61326:2004

## Signal diagram

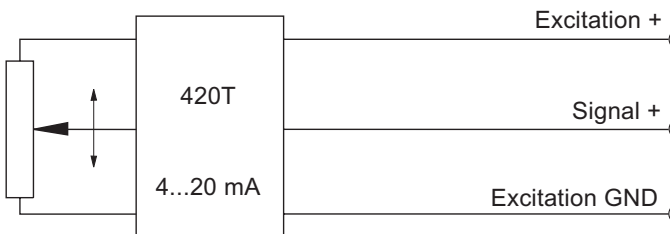

Signal Wiring	Output signals		Cable color	Connector pin no.
	420A	420T		
	Signal +	Excitation +	White	1
	Signal -	Excitation GND	Brown	2
		Signal +	Green	3

## Connection Mating Connector

View to solder terminals

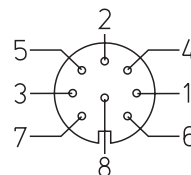

CONN-DIN-8F-W

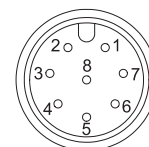

CONN-M12-8F-G

# Output Specification

## PMU for IWS position sensors

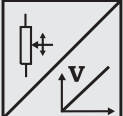
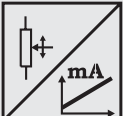
<b>Signal Conditioner PMU, adjustable</b> Voltage output and current output (3 wire)  	Excitation voltage	+18 ... 27 V DC
	Excitation current	50 mA max.
	Voltage output	0 ... 10 V
	Output current	10 mA max.
	Output load	1 kΩ min.
	Current output	4 ... 20 mA (3 wire)
	Load resistor	500 Ω max.
	Adjustment	
	Activation of offset and gain adjust	Connect with excitation GND (0 V)
	Scalable range	90 % max. full scale
	Stability (Temperature)	$\pm 50 \times 10^{-6} / ^\circ\text{C}$ full scale
	Protection	Reverse polarity, short circuit
	Output noise	1 mV <sub>eff</sub>
Operating temperature	-20 ... +85 °C	
EMC	According to EN 61326:2004	

### Signal diagram

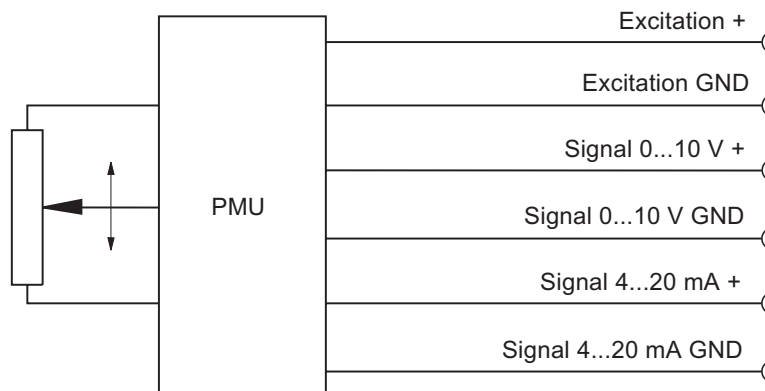

Signal wiring	Output signals	Connector pin no.
	Excitation +	1
	Excitation GND	2
	Signal 0...10 V +	3
	Signal 0...10 V GND	4
	Signal 4...20 mA +	5
	Signal 4...20 mA GND	6
	Offset	7
	Gain	8

### Connection

Mating Connector

